



## Accessories

Fittings, Flow Controls, Mufflers, Pressure Switches & Replacement Parts





## Accessories

World Thread™ Fittings	2
NPTF/Inch Tube Fittings	7
Metric Fittings	14
World Thread™ Flow Controls	20
Valves and Flow Controls	21
Pilot Operated Check Valves	24
Quick Exhaust, Slide, and Shuttle Valves	25
Silencers	26
Mufflers	28
Breather Vent Silencer	29
Inlet Filter Strainer	29
Check Valves	30
Tubing	31
Electronic Drain Valves	35
Pressure Switches	36
12, 14, 22, 32, and 42 Series Replacement Parts	37

How to Order

World Thread™ Fittings

<p><b>Fitting Series</b> INWB = World Thread™ Inch Tube (All Brass) NWB = World Thread™ Metric Tube (All Brass)</p> <p><b>Fitting Style</b> 103 = Straight 109 = Swivel Elbow 109E = Extended Swivel Elbow 114 = Swivel Branch Tee 116 = Swivel Run Tee</p>	<p><b>INWB</b>   <b>103</b>   <b>104</b>   <b>022</b></p>	<p><b>Options</b> (blank) = Buna-N O-ring F = FKM O-ring</p> <table border="0"> <tr> <td><b>INW Thread Size</b></td> <td><b>NWB Thread Size</b></td> </tr> <tr> <td>020 = 1/8"</td> <td>000 = 1/8"</td> </tr> <tr> <td>021 = 1/4"</td> <td>001 = 1/4"</td> </tr> <tr> <td>022 = 3/8"</td> <td>002 = 3/8"</td> </tr> <tr> <td>023 = 1/2"</td> <td>003 = 1/2"</td> </tr> </table> <table border="0"> <tr> <td><b>* Tube Size</b></td> <td><b>Inch</b></td> <td><b>Metric</b></td> </tr> <tr> <td></td> <td>108 = 1/8"</td> <td>004 = 4mm</td> </tr> <tr> <td></td> <td>532 = 5/32"</td> <td>005 = 5mm</td> </tr> <tr> <td></td> <td>104 = 1/4"</td> <td>006 = 6mm</td> </tr> <tr> <td></td> <td>516 = 5/16"</td> <td>008 = 8mm</td> </tr> <tr> <td></td> <td>308 = 3/8"</td> <td>010 = 10mm</td> </tr> <tr> <td></td> <td>102 = 1/2"</td> <td>012 = 12mm</td> </tr> </table>	<b>INW Thread Size</b>	<b>NWB Thread Size</b>	020 = 1/8"	000 = 1/8"	021 = 1/4"	001 = 1/4"	022 = 3/8"	002 = 3/8"	023 = 1/2"	003 = 1/2"	<b>* Tube Size</b>	<b>Inch</b>	<b>Metric</b>		108 = 1/8"	004 = 4mm		532 = 5/32"	005 = 5mm		104 = 1/4"	006 = 6mm		516 = 5/16"	008 = 8mm		308 = 3/8"	010 = 10mm		102 = 1/2"	012 = 12mm
<b>INW Thread Size</b>	<b>NWB Thread Size</b>																																
020 = 1/8"	000 = 1/8"																																
021 = 1/4"	001 = 1/4"																																
022 = 3/8"	002 = 3/8"																																
023 = 1/2"	003 = 1/2"																																
<b>* Tube Size</b>	<b>Inch</b>	<b>Metric</b>																															
	108 = 1/8"	004 = 4mm																															
	532 = 5/32"	005 = 5mm																															
	104 = 1/4"	006 = 6mm																															
	516 = 5/16"	008 = 8mm																															
	308 = 3/8"	010 = 10mm																															
	102 = 1/2"	012 = 12mm																															

\* See Fitting Style Charts on pages 3 – 6 for available Tube and Thread Configurations.

- Pressure Rating to 265 psi
- Temperature Range:  
-20 °F to 176 °F (Buna-N O-ring)  
-20 °F to 230 °F (FKM O-ring)
- Tube Diameter:  
1/8" to 1/2"  
4mm to 12mm
- Thread Size: 1/8" to 1/2"

Numatics' World Thread™ IN Fittings provide extreme versatility in use, which no longer requires the management of different fittings for different thread types or application.

- Extremely versatile – One fitting design for multiple thread types
- Rapid assembly – Requires fewer turns to tighten and seal
- Reusable – Fittings can be used several times without gasket deterioration
- Reliable seal – Helical thread profile and PTFE gasket ensure proper seal
- Maximum working pressure: 265 PSIG at 68 °F (18 bar at 20°C)
- Conductor compatibility – Nylon, Polyurethane, Polyethylene

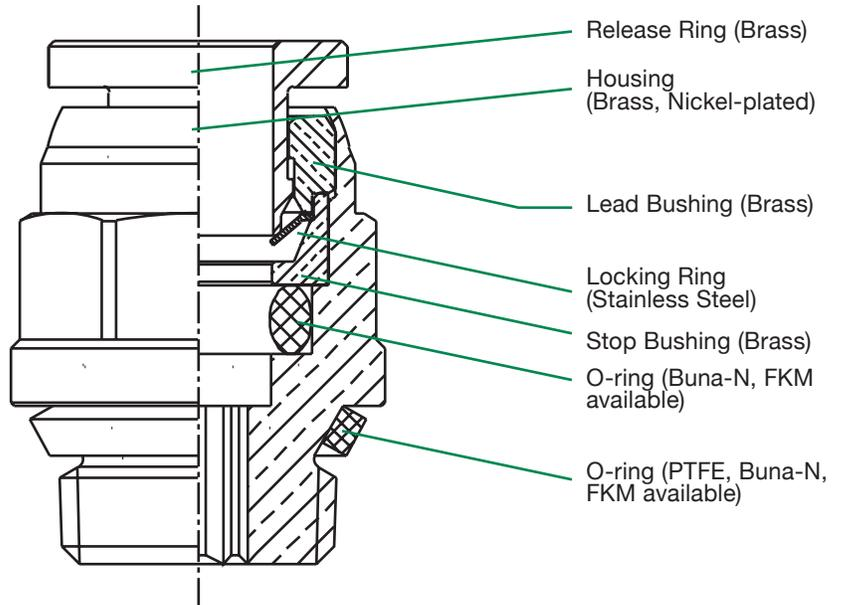

Numatics' World Thread™ is designed with a helical thread design that represents the envelope for the profile of the NPTF, ISO 228/1 (BSPP), (G-Tap), ISO 7/1 (BSPT), (JIS B 0202) and (JIS B 0203) thread types. In conjunction with the thread design the seal between the male and female threads is created with a PTFE gasket, housed in a groove at the rear of the thread. This gasket seal meets UNI 571-65 standards.

### Dimensions: inches

### Dimensional Drawings - INWB103 Male Connector/Inch Tube

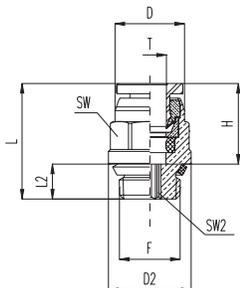

Brass Release Ring	INWB103	Tube Diameter (T)	Thread (F)	D	D2	L	L2	H	SW	SW2
INWB	103-108-020	1/8	1/8	0.370	0.472	0.709	0.217	0.472	0.375	0.063
INWB	103-108-021	1/8	1/4	0.370	0.591	0.787	0.303	0.472	0.375	0.063
INWB	103-532-020	5/32	1/8	0.390	0.512	0.709	0.217	0.492	0.438	0.063
INWB	103-532-021	5/32	1/4	0.390	0.591	0.795	0.303	0.492	0.438	0.063
INWB	103-104-020	1/4	1/8	0.465	0.552	0.799	0.217	0.531	0.500	0.156
INWB	103-104-021	1/4	1/4	0.465	0.591	0.886	0.303	0.531	0.500	0.156
INWB	103-104-022	1/4	3/8	0.465	0.748	0.906	0.323	0.531	0.500	0.156
INWB	103-516-020	5/16	1/8	0.689	0.787	0.925	0.323	0.650	0.594	0.156
INWB	103-516-021	5/16	1/4	0.689	0.945	1.004	0.406	0.650	0.594	0.219
INWB	103-516-022	5/16	3/8	0.807	0.866	1.004	0.303	0.650	0.594	0.219
INWB	103-308-020	3/8	1/8	0.807	0.866	1.043	0.323	0.669	0.688	0.156
INWB	103-308-021	3/8	1/4	0.807	0.945	1.043	0.406	0.669	0.688	0.219
INWB	103-308-022	3/8	3/8	0.807	0.866	1.071	0.323	0.669	0.688	0.250
INWB	103-308-023	3/8	1/2	0.807	0.945	1.161	0.406	0.669	0.688	0.250
INWB	103-102-021	1/2	1/4	0.807	0.945	1.142	0.406	0.728	0.813	0.250
INWB	103-102-022	1/2	3/8	0.807	0.866	1.181	0.323	0.728	0.813	0.250
INWB	103-102-023	1/2	1/2	0.807	0.945	1.220	0.406	0.728	0.813	0.375

### INWB109 Swivel Elbow/Inch Tube

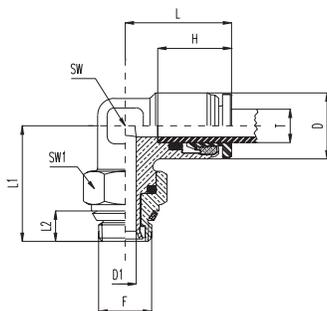

Brass Release Ring	INWB109	Tube Diameter (T)	Thread (F)	D	D1	L	L1	L2	H	SW	SW1
INWB	109-108-020	1/8	1/8	0.394	0.157	0.650	0.768	0.217	0.472	0.354	0.500
INWB	109-108-021	1/8	1/4	0.394	0.157	0.650	0.768	0.303	0.472	0.354	0.594
INWB	109-532-021	5/32	1/4	0.394	0.157	0.669	0.874	0.303	0.492	0.354	0.594
INWB	109-104-020	1/4	1/8	0.472	0.157	0.768	0.799	0.217	0.531	0.433	0.500
INWB	109-104-021	1/4	1/4	0.472	0.236	0.768	0.8155	0.303	0.531	0.433	0.594
INWB	109-516-020	1/4	1/8	0.472	0.236	0.768	0.906	0.323	0.531	0.433	0.750
INWB	109-516-021	5/16	1/4	0.591	0.157	0.945	0.878	0.217	0.650	0.551	0.500
INWB	109-308-020	3/8	1/8	0.689	0.157	1.063	0.929	0.217	0.669	0.630	0.500
INWB	109-308-021	3/8	1/4	0.689	0.236	1.063	0.945	0.303	0.669	0.630	0.594
INWB	109-308-022	3/8	3/8	0.689	0.315	1.063	1.039	0.323	0.669	0.630	0.750
INWB	109-308-023	3/8	1/2	0.689	0.315	1.063	1.197	0.406	0.669	0.630	0.938
INWB	109-102-021	1/2	1/4	0.827	0.236	1.201	1.059	0.303	0.728	0.688	0.594
INWB	109-102-022	1/2	3/8	0.827	0.315	1.201	1.122	0.323	0.728	0.688	0.750
INWB	109-102-023	1/2	1/2	0.827	0.315	1.201	1.280	0.406	0.728	0.688	0.938

### INWB109E Extended Swivel Elbow/Inch Tube

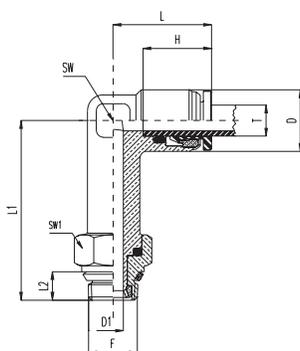

Brass Release Ring	INWB109E	Tube Diameter (T)	Thread (F)	D	D1	L	L1	L2	H	SW	SW1
INWB	109E-108-020	1/8	1/8	0.709	0.236	1.043	2.067	0.512	0.531	0.591	0.591
INWB	109E-108-021	1/8	1/4	0.748	0.315	1.043	2.106	0.512	0.531	0.591	0.709
INWB	109E-532-020	5/32	1/8	0.394	0.157	0.638	1.461	0.374	0.472	0.354	0.512
INWB	109E-532-021	5/32	1/4	0.394	0.157	0.638	1.598	0.512	0.472	0.354	0.591
INWB	109E-104-020	1/4	1/8	0.394	0.157	0.657	1.457	0.374	0.492	0.354	0.512
INWB	109E-104-021	1/4	1/4	0.394	0.157	0.657	1.594	0.512	0.492	0.354	0.591
INWB	109E-104-022	1/4	3/8	0.472	0.157	0.740	1.575	0.374	0.531	0.433	0.512
INWB	109E-516-020	5/16	1/8	0.472	0.236	0.740	1.693	0.512	0.531	0.433	0.591
INWB	109E-516-021	5/16	1/4	0.472	0.236	0.740	1.732	0.512	0.531	0.433	0.709
INWB	109E-516-022	5/16	3/8	0.591	0.157	0.925	1.772	0.374	0.531	0.551	0.512
INWB	109E-308-020	3/8	1/8	0.591	0.236	0.925	1.909	0.512	0.531	0.551	0.591
INWB	109E-308-021	3/8	1/4	0.630	0.315	0.925	1.969	0.512	0.531	0.551	0.709
INWB	109E-308-022	3/8	3/8	0.669	0.157	1.043	1.929	0.374	0.531	0.591	0.512

### Dimensions: inches

### Dimensional Drawings - INWB114 Swivel Branch Tee/Inch Tube

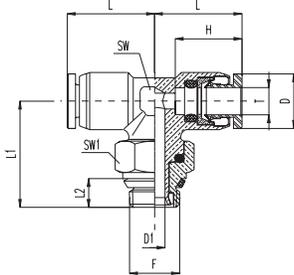

Brass Release Ring	INWB114	Tube Diameter (T)	Thread (F)	D	D1	L	L1	L2	H	SW	SW1
INWB	114-108-020	1/8	1/8	0.394	0.157	0.650	0.768	0.217	0.472	0.354	0.500
INWB	114-108-021	1/8	1/4	0.394	0.157	0.650	0.787	0.303	0.472	0.354	0.594
INWB	114-532-020	5/32	1/8	0.394	0.157	0.669	0.768	0.217	0.492	0.354	0.500
INWB	114-104-020	1/4	1/8	0.472	0.157	0.768	0.886	0.217	0.531	0.433	0.500
INWB	114-104-021	1/4	1/4	0.472	0.236	0.768	0.906	0.303	0.531	0.433	0.594
INWB	114-104-022	1/4	3/8	0.472	0.236	0.768	0.965	0.323	0.531	0.433	0.750
INWB	114-516-020	5/16	1/8	0.591	0.157	0.945	0.874	0.217	0.650	0.551	0.500
INWB	114-516-021	5/16	1/4	0.591	0.236	0.945	0.886	0.303	0.650	0.551	0.594
INWB	114-308-020	3/8	1/8	0.689	0.157	1.063	0.925	0.217	0.669	0.630	0.500
INWB	114-308-021	3/8	1/4	0.689	0.236	1.063	0.945	0.303	0.669	0.630	0.594
INWB	114-308-022	3/8	3/8	0.689	0.315	1.063	1.043	0.323	0.669	0.630	0.750
INWB	114-308-023	3/8	1/2	0.689	0.315	1.063	1.201	0.406	0.669	0.630	0.938
INWB	114-102-021	1/2	1/4	0.827	0.236	1.201	1.063	0.303	0.728	0.688	0.594
INWB	114-102-022	1/2	3/8	0.827	0.315	1.201	1.122	0.323	0.728	0.688	0.750
INWB	114-102-023	1/2	1/2	0.827	0.315	1.201	1.280	0.406	0.728	0.688	0.938

### INWB116 Swivel Run Tee/Inch Tube

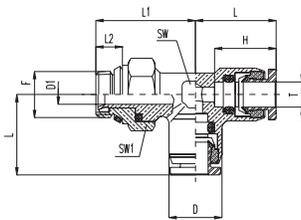

Brass Release Ring	INWB116	Tube Diameter (T)	Thread (F)	D	D1	L	L1	L2	H	SW	SW1
INWB	116-108-020	1/8	1/8	0.394	0.157	0.650	0.768	0.217	0.472	0.354	0.500
INWB	116-532-020	5/32	1/8	0.394	0.157	0.650	0.768	0.217	0.492	0.354	0.500
INWB	116-532-021	5/32	1/4	0.394	0.157	0.638	0.787	0.303	0.492	0.354	0.594
INWB	116-104-020	1/4	1/8	0.472	0.157	0.638	0.886	0.217	0.531	0.433	0.500
INWB	116-104-021	1/4	1/4	0.472	0.236	0.657	0.906	0.303	0.531	0.433	0.594
INWB	116-104-022	1/4	3/8	0.472	0.236	0.657	0.965	0.323	0.531	0.433	0.750
INWB	116-516-020	5/16	1/8	0.591	0.157	0.740	0.874	0.217	0.650	0.551	0.500
INWB	116-516-021	5/16	1/4	0.591	0.236	0.740	0.886	0.303	0.650	0.551	0.594
INWB	116-308-021	3/8	1/4	0.689	0.236	0.925	0.945	0.303	0.669	0.630	0.594
INWB	116-308-022	3/8	3/8	0.689	0.315	0.925	1.043	0.323	0.669	0.630	0.750
INWB	116-308-023	3/8	1/2	0.689	0.315	0.925	1.201	0.406	0.669	0.630	0.938
INWB	116-102-021	1/2	1/4	0.827	0.236	1.043	1.063	0.303	0.728	0.688	0.594
INWB	116-102-022	1/2	3/8	0.827	0.315	1.043	1.122	0.323	0.728	0.688	0.750
INWB	116-102-023	1/2	1/2	0.827	0.315	1.043	1.280	0.406	0.728	0.688	0.938

Dimensions: mm

### Dimensional Drawings - NWB103 Male Connector/Metric Tube

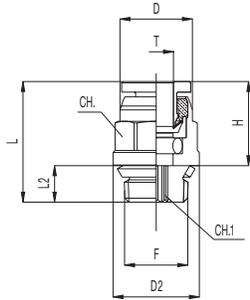

NWB103	Tube Diameter (T)	Thread (F)	D	D2	L	L2	H	CH.	CH.1
NWB103-004-000	4	1/8	10.0	12	17.5	5.5	12.5	10	3
NWB103-004-001	4	1/4	10.0	15	20.5	7.7	12.5	10	3
NWB103-005-000	5	1/8	11.0	12	18.5	5.5	13.0	11	3
NWB103-005-001	5	1/4	11.0	15	21.0	7.7	13.0	11	3
NWB103-006-000	6	1/8	12.0	14	19.0	5.5	13.5	12	4
NWB103-006-001	6	1/4	12.0	15	21.0	7.7	13.5	12	4
NWB103-008-000	8	1/8	15.0	16	23.5	5.5	16.0	15	5
NWB103-008-001	8	1/4	15.0	16	23.5	7.7	16.0	15	6
NWB103-008-002	8	3/8	15.0	19	24.5	8.2	16.0	15	6
NWB103-010-001	10	1/4	17.5	20	27.0	7.7	17.0	18	6
NWB103-010-002	10	3/8	17.5	20	25.0	8.2	17.0	18	7
NWB103-010-003	10	1/2	17.5	24	28.5	10.3	17.0	18	7
NWB103-012-001	12	1/4	20.5	22	28.0	7.7	19.0	20	6
NWB103-012-002	12	3/8	20.5	22	28.5	8.2	19.0	20	8
NWB103-012-003	12	1/2	20.5	24	31.0	10.3	19.0	20	9

### NWB109 Swivel Elbow/Metric Tube

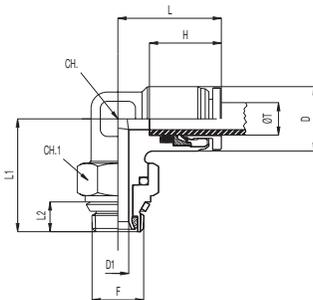

NWB109	Tube Diameter (T)	Thread (F)	D	D1	L	L1	L2	H	CH.	CH.1
NWB109-004-000	4	1/8	10.0	4	16.5	19.5	5.5	12.5	9	13
NWB109-004-001	4	1/4	10.0	4	16.5	20.0	7.7	12.5	9	15
NWB109-005-000	5	1/8	11.0	4	16.5	21.0	5.5	13.0	10	13
NWB109-005-001	5	1/4	11.0	4	16.5	21.5	7.7	13.0	10	15
NWB109-006-000	6	1/8	12.0	4	19.0	20.5	5.5	13.5	11	13
NWB109-006-001	6	1/4	12.0	4	19.0	21.0	7.7	13.5	11	15
NWB109-008-000	8	1/8	15.0	4	23.5	22.5	5.5	16.0	14	13
NWB109-008-001	8	1/4	15.0	6	23.5	23.0	7.7	16.0	14	15
NWB109-008-002	8	3/8	15.0	8	23.5	25.5	8.2	16.0	14	19
NWB109-010-001	10	1/4	17.5	6	26.5	23.7	7.7	17.0	16	15
NWB109-010-002	10	3/8	17.5	8	26.5	26.4	8.2	17.0	16	19
NWB109-010-003	10	1/2	17.5	8	26.5	30.5	11.8	16.8	16	19
NWB109-012-001	12	1/4	20.5	6	29.1	27.1	7.7	18.6	17	15
NWB109-012-002	12	3/8	20.5	8	29.1	28.5	8.2	18.6	17	19
NWB109-012-003	12	1/2	20.5	8	29.1	32.5	8.2	17.0	15	19

### NWB109E Extended Swivel Elbow/Metric Tube

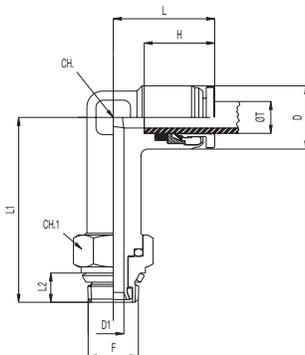

NWB109E	Tube Diameter (T)	Thread (F)	D	D1	L	L1	L2	H	CH.	CH.1
NWB109E-004-000	4	1/8	10.0	4	16.5	34.5	5.5	12.5	9	13
NWB109E-004-001	4	1/4	10.0	4	16.5	35	7.7	12.5	9	15
NWB109E-006-000	6	1/8	12.0	4	19	37.5	5.5	13.5	11	13
NWB109E-006-001	6	1/4	12.0	6	19	38	7.7	13.5	11	15
NWB109E-008-000	8	1/8	15.0	4	23.5	42.5	5.5	16	14	13
NWB109E-008-001	8	1/4	15.0	6	23.5	42.5	7.7	16	14	15
NWB109E-008-002	8	3/8	15.0	8	23.5	45.2	8.2	16	14	19
NWB109E-010-001	10	1/4	17.5	6	26.5	46.5	7.7	17	15	15
NWB109E-010-002	10	3/8	17.5	8	26.5	49	8.2	17	14	19

Dimensions: mm

### Dimensional Drawings - NWB114 Swivel Branch Tee/Metric Tube

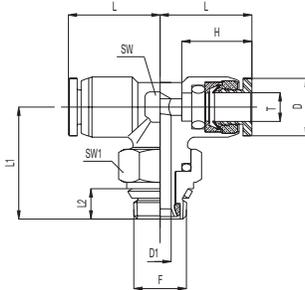

NWB114	Tube Diameter (T)	Thread (F)	D	D1	L	L1	L2	H	SW	SW1
NWB114-004-000	4	1/8	10.0	4	16.5	19.5	5.5	12.5	9	13
NWB114-005-000	5	1/8	11.0	4	16.5	21.0	5.5	13.0	10	13
NWB114-006-000	6	1/8	12.0	4	19.0	22.7	5.5	13.5	11	13
NWB114-006-001	6	1/4	12.0	6	19.0	23.6	7.7	13.5	11	15
NWB114-008-000	8	1/8	15.0	4	23.5	22.3	5.5	16.0	14	13
NWB114-008-001	8	1/4	15.0	6	23.5	22.5	7.7	16.0	14	15
NWB114-008-002	8	3/8	15.0	8	23.5	25.2	8.2	16.0	14	19
NWB114-010-001	10	1/4	17.5	6	26.5	23.7	7.7	17.0	15	15
NWB114-010-002	10	3/8	17.5	8	26.5	28.5	8.2	17.0	15	19
NWB114-010-003	10	1/2	17.5	8	26.5	26.5	8.2	16.8	16	19
NWB114-012-001	12	1/4	20.5	6	29.1	27.1	7.7	17.0	15	15
NWB114-012-002	12	3/8	20.5	8	29.1	28.5	8.2	17.0	15	19
NWB114-012-003	12	1/2	20.5	8	29.1	32.5	8.2	17.0	15	19

### NWB116 Swivel Run Tee/Metric Tube

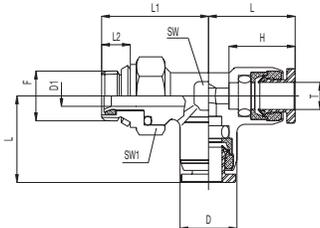

NWB116	Tube Diameter (T)	Thread (F)	D	D1	L	L1	L2	H	SW	SW1
NWB116-004-000	4	1/8	10.0	4	16.5	19.5	5.5	12.5	9	13
NWB116-005-000	5	1/8	11.0	4	16.5	19.6	5.5	13.0	10	13
NWB116-006-000	6	1/8	12.0	4	19.0	22.3	5.5	13.5	11	13
NWB116-006-001	6	1/4	12.0	6	19.0	23.6	7.7	13.5	11	15
NWB116-008-000	8	1/8	15.0	4	23.2	22.3	5.5	16.0	14	13
NWB116-008-001	8	1/4	15.0	6	23.2	22.5	7.7	16.0	14	15
NWB116-008-002	8	3/8	15.0	8	23.4	25.2	8.2	16.0	14	19
NWB116-010-001	10	1/4	17.5	6	26.5	23.7	7.7	17.0	15	15
NWB116-010-002	10	3/8	17.5	8	26.5	26.4	8.2	17.0	15	19
NWB116-010-003	10	1/2	17.5	8	26.5	26.5	8.2	16.8	16	19
NWB116-012-001	12	1/4	20.5	6	29.1	27.1	7.7	17.0	15	15
NWB116-012-002	12	3/8	20.5	8	29.1	28.5	8.2	17.0	15	19
NWB116-012-003	12	1/2	20.5	8	29.1	32.5	8.2	17.0	15	19



### How to Order

#### NPTF/Inch Tube Fittings

<p><b>Fitting Series</b></p> <p>INB = NPTF/Inch Tube (Brass Release Ring)</p> <p><sup>1</sup> IN = NPTF/Inch Tube</p> <p><b>Fitting Style</b></p> <p>100 = Union                                   <sup>1</sup> 118 = Plug</p> <p>101 = Bulkhead Union                   <sup>1</sup> 119 = Double Male Union</p> <p>103 = Male Connector                   <sup>1</sup> 120 = Stem Adapter</p> <p>105 = Female Connector               121 = Reducer</p> <p>106 = Union Elbow                       122 = Single Banjo</p> <p>107 = Fixed Elbow                       123 = Double Banjo</p> <p>109 = Swivel Elbow                     <sup>1</sup> 124 = Single Manifold</p> <p>109E = Extended Swivel Elbow   <sup>1</sup> 125 = Double Manifold</p> <p>110 = Union Tee                         131 = Union Y</p> <p>114 = Swivel Branch Tee             132 = Male Y</p> <p>116 = Swivel Run Tee</p>	<p><b>Options</b></p> <p>(blank) = Buna-N O-ring</p> <p>F = FKM O-ring</p> <p><b>Thread Size</b></p> <p>000 = No Thread</p> <p>0036 = 10-31 UNF</p> <p>020 = 1/8 NPTF</p> <p>021 = 1/4 NPTF</p> <p>022 = 3/8 NPTF</p> <p>023 = 1/2 NPTF</p> <p><b><sup>2</sup> Tube Size</b></p> <p>108 = 1/8"</p> <p>532 = 5/32"</p> <p>104 = 1/4"</p> <p>516 = 5/16"</p> <p>308 = 3/8"</p> <p>102 = 1/2"</p> <p>000 = No Tube</p>
--	---

<sup>1</sup> These fittings are only available in IN Fitting Series. All other styles are only available in INB Fitting Series.

<sup>2</sup> See Fitting Style Charts on pages 8 – 13 for available Tube and Thread Configurations.

- Pressure Rating to 265 psi
- Temperature Range:
  - 20 °F to 176 °F (Buna-N O-ring)
  - 20 °F to 230 °F (FKM O-ring)
- Push-in fittings with NPTF threads
- PTFE thread sealant
- Tube Diameter: 1/8" to 1/2"
- Thread Size: 10-32 UNF to 1/2 NPTF

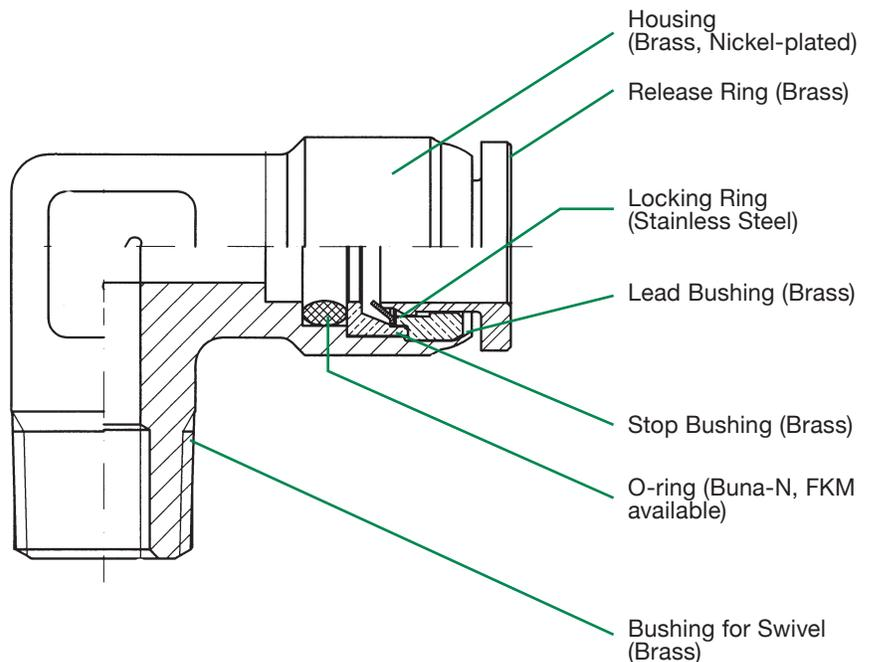

### Dimensions: inches

### Dimensional Drawings - INB100 Union

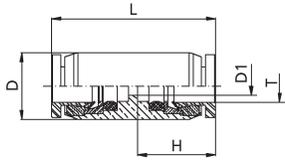

Brass Release Ring	INB100	Tube Diameter (T)	D	D1	L	H
INB	100-108-000	1/8	0.394	0.094	0.984	0.472
INB	100-532-000	5/32	0.394	0.118	1.024	0.492
INB	100-104-000	1/4	0.472	0.157	1.110	0.531
INB	100-516-000	5/16	0.591	0.236	1.299	0.630
INB	100-308-000	3/8	0.709	0.276	1.398	0.669
INB	100-102-000	1/2	0.787	0.413	1.575	0.748

### INB101 Bulkhead Union

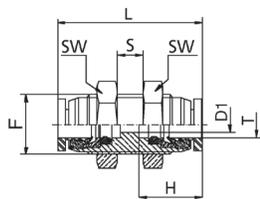

Brass Release Ring	INB101	Tube Diameter (T)	Thread (F)	D1	L	H	Max. S	SW
INB	101-108-000	1/8	M11x1	0.094	1.091	0.472	0.197	0.551
INB	101-532-000	5/32	M12x1	0.118	1.130	0.492	0.236	0.551
INB	101-104-000	1/4	M13x1	0.157	1.244	0.531	0.315	0.630
INB	101-516-000	5/16	M16x1	0.236	1.437	0.630	0.315	0.748
INB	101-308-000	3/8	M19x1	0.276	1.614	0.669	0.433	0.866
INB	101-102-000	1/2	M22x1	0.413	1.850	0.748	0.591	1.024

### INB103 Male Connector

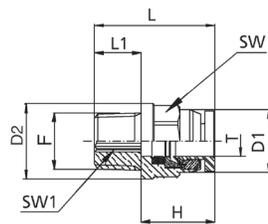

Brass Release Ring	INB103	Tube Diameter (T)	Thread (F)	D1	D2	L	L1	H	SW	SW1
INB	103-108-036	1/8	10-32 UNF	0.370	0.370	0.697	0.165	0.472	-	5/64
INB	103-108-020	1/8	1/8 NPTF	0.370	0.472	0.854	0.374	0.472	3/8	5/64
INB	103-108-021	1/8	1/4 NPTF	0.370	0.551	0.992	0.512	0.472	3/8	5/64
INB	103-532-036	5/32	10-32 UNF	0.394	0.394	0.717	0.165	0.492	-	5/64
INB	103-532-020	5/32	1/8 NPTF	0.394	0.512	0.866	0.374	0.492	7/16	5/64
INB	103-532-021	5/32	1/4 NPTF	0.394	0.551	1.004	0.512	0.492	7/16	5/64
INB	103-104-036	1/4	10-32 UNF	0.472	0.472	0.772	0.165	0.531	-	5/64
INB	103-104-020	1/4	1/8 NPTF	0.472	0.551	0.886	0.374	0.531	1/2	5/32
INB	103-104-021	1/4	1/4 NPTF	0.472	0.551	1.024	0.512	0.531	1/2	5/32
INB	103-104-022	1/4	3/8 NPTF	0.472	0.709	1.024	0.512	0.531	1/2	5/32
INB	103-516-020	5/16	1/8 NPTF	0.591	0.669	1.055	0.374	0.630	19/32	7/32
INB	103-516-021	5/16	1/4 NPTF	0.591	0.669	1.173	0.512	0.630	19/32	7/32
INB	103-516-022	5/16	3/8 NPTF	0.591	0.709	1.173	0.512	0.630	19/32	7/32
INB	103-308-020	3/8	1/8 NPTF	0.669	0.787	1.114	0.374	0.669	11/16	7/32
INB	103-308-021	3/8	1/4 NPTF	0.669	0.787	1.232	0.512	0.669	11/16	1/4
INB	103-308-022	3/8	3/8 NPTF	0.669	0.787	1.232	0.512	0.669	11/16	1/4
INB	103-308-023	3/8	1/2 NPTF	0.669	0.866	1.390	0.709	0.669	11/16	1/4
INB	103-102-021	1/2	1/4 NPTF	0.827	0.906	1.339	0.512	0.748	13/16	1/4
INB	103-102-022	1/2	3/8 NPTF	0.827	0.906	1.339	0.512	0.748	13/16	3/8
INB	103-102-023	1/2	1/2 NPTF	0.827	0.906	1.496	0.709	0.748	13/16	3/8

### INB105 Female Connector

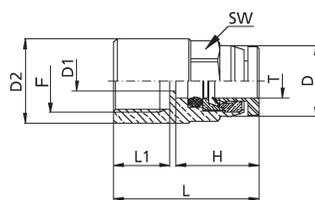

Brass Release Ring	INB105	Tube Diameter (T)	Thread (F)	D	D1	D2	L	L1	H	SW
INB	105-108-020	1/8	1/8 NPTF	0.370	0.094	0.551	0.945	0.335	0.472	3/8
INB	105-108-021	1/8	1/4 NPTF	0.370	0.094	0.669	1.102	0.472	0.472	3/8
INB	105-532-020	5/32	1/8 NPTF	0.394	0.118	0.551	0.965	0.335	0.492	7/16
INB	105-532-021	5/32	1/4 NPTF	0.394	0.118	0.669	1.122	0.472	0.492	7/16
INB	105-104-020	1/4	1/8 NPTF	0.472	0.157	0.551	0.965	0.335	0.531	1/2
INB	105-104-021	1/4	1/4 NPTF	0.472	0.157	0.669	1.142	0.472	0.531	1/2
INB	105-516-020	5/16	1/8 NPTF	0.591	0.236	0.669	1.055	0.335	0.630	19/32
INB	105-516-021	5/16	1/4 NPTF	0.591	0.236	0.669	1.213	0.472	0.630	19/32
INB	105-308-021	3/8	1/4 NPTF	0.669	0.276	0.866	1.248	0.472	0.669	3/4
INB	105-308-022	3/8	3/8 NPTF	0.669	0.276	0.866	1.366	0.495	0.669	11/16

### Dimensions: inches

### Dimensional Drawings - INB106 Union Elbow

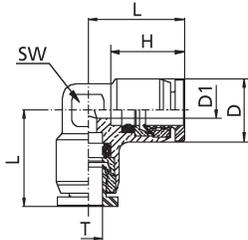

Brass Release Ring	INB106	Tube Diameter (T)	D	D1	L	H	SW
INB	106-108-000	1/8	0.394	0.094	0.638	0.472	0.354
INB	106-532-000	5/32	0.394	0.118	0.657	0.492	0.354
INB	106-104-000	1/4	0.472	0.157	0.740	0.531	0.433
INB	106-516-000	5/16	0.591	0.236	0.858	0.630	0.551
INB	106-308-000	3/8	0.709	0.295	1.004	0.669	0.630
INB	106-102-000	1/2	0.827	0.413	1.161	0.748	0.685

### INB107 Fixed Elbow

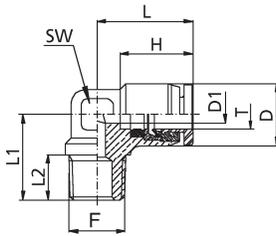

Brass Release Ring	INB107	Tube Diameter (T)	Thread (F)	D	D1	L	L1	L2	H	SW
INB	107-532-020	5/32	1/8 NPTF	0.394	0.118	0.657	0.650	0.374	0.492	0.354
INB	107-532-021	5/32	1/4 NPTF	0.394	0.118	0.657	0.787	0.512	0.492	0.354
INB	107-104-020	1/4	1/8 NPTF	0.472	0.157	0.740	0.693	0.374	0.531	0.433
INB	107-104-021	1/4	1/4 NPTF	0.472	0.157	0.740	0.831	0.512	0.531	0.433
INB	107-308-021	3/8	1/4 NPTF	0.709	0.295	1.004	0.945	0.512	0.685	0.630
INB	107-308-022	3/8	3/8 NPTF	0.709	0.295	1.004	1.945	0.512	0.685	0.630

### INB109 Swivel Elbow

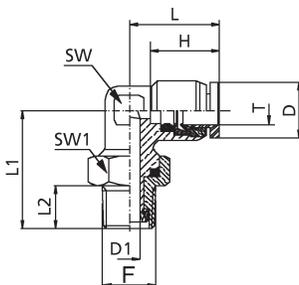

Brass Release Ring	INB109	Tube Diameter (T)	Thread (F)	D	D1	L	L1	L2	H	SW	SW1
INB	109-108-036	1/8	10-32 UNF	0.394	0.087	0.638	0.630	0.165	0.472	0.354	0.354
INB	109-108-020	1/8	1/8 NPTF	0.394	0.157	0.638	0.874	0.374	0.472	0.354	0.512
INB	109-108-021	1/8	1/4 NPTF	0.394	0.157	0.638	1.008	0.512	0.472	0.354	0.591
INB	109-532-036	5/32	10-32 UNF	0.394	0.087	0.657	0.630	0.165	0.492	0.354	0.354
INB	109-532-020	5/32	1/8 NPTF	0.394	0.157	1.657	0.874	0.374	0.492	0.354	0.512
INB	109-532-021	5/32	1/4 NPTF	0.394	0.157	1.657	1.008	0.512	0.492	0.354	0.591
INB	109-104-036	1/4	10-32 UNF	0.472	0.087	0.740	0.709	0.165	0.531	0.433	0.354
INB	109-104-020	1/4	1/8 NPTF	0.472	0.157	0.740	0.906	0.374	0.531	0.433	0.512
INB	109-104-021	1/4	1/4 NPTF	0.472	0.236	0.740	1.031	0.512	0.531	0.433	0.591
INB	109-104-022	1/4	3/8 NPTF	0.472	0.236	0.740	1.071	0.512	0.531	0.433	0.709
INB	109-516-020	5/16	1/8 NPTF	0.591	0.157	0.925	0.984	0.374	0.630	0.551	0.512
INB	109-516-021	5/16	1/4 NPTF	0.591	0.236	0.925	1.122	0.512	0.630	0.551	0.591
INB	109-516-022	5/16	3/8 NPTF	0.591	0.315	0.925	1.181	0.512	0.630	0.551	0.709
INB	109-308-020	3/8	1/8 NPTF	0.709	0.157	1.043	1.043	0.374	0.669	0.630	0.512
INB	109-308-021	3/8	1/4 NPTF	0.709	0.236	1.043	1.181	0.512	0.669	0.630	0.591
INB	109-308-022	3/8	3/8 NPTF	0.709	0.315	1.043	1.220	0.512	0.669	0.630	0.709
INB	109-308-023	3/8	1/2 NPTF	0.709	0.315	1.043	1.358	0.709	0.669	0.630	0.866
INB	109-102-021	1/2	1/4 NPTF	0.827	0.236	1.181	1.299	0.512	0.748	0.685	0.591
INB	109-102-022	1/2	3/8 NPTF	0.827	0.315	1.181	1.299	0.512	0.748	0.685	0.709
INB	109-102-023	1/2	1/2 NPTF	0.827	0.315	1.181	1.476	0.709	0.748	0.685	0.866

Dimensions: inches

Dimensional Drawings - INB109E Extended Swivel Elbow

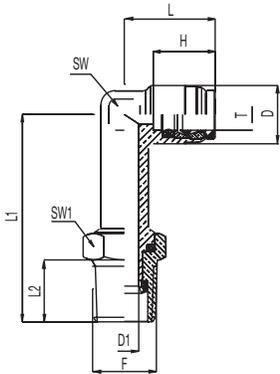

Brass Release Ring	INB109E	Tube Diameter (T)	Thread (F)	D	D1	L	L1	L2	H	SW	SW1
INB	109E-108-020	1/8	1/8 NPTF	0.394	0.157	0.638	1.461	0.374	0.472	0.354	0.512
INB	109E-108-021	1/8	1/4 NPTF	0.394	0.157	0.638	1.598	0.512	0.472	0.354	0.591
INB	109E-532-020	5/32	1/8 NPTF	0.394	0.157	0.657	1.457	0.374	0.492	0.354	0.512
INB	109E-104-020	1/4	1/8 NPTF	0.472	0.157	0.740	1.575	0.374	0.531	0.433	0.512
INB	109E-104-021	1/4	1/4 NPTF	0.472	0.236	0.740	1.693	0.512	0.531	0.433	0.591
INB	109E-104-022	1/4	3/8 NPTF	0.472	0.236	0.740	1.732	0.512	0.531	0.433	0.709
INB	109E-516-021	5/16	1/4 NPTF	0.591	0.236	0.925	1.909	0.512	0.531	0.551	0.591
INB	109E-308-020	3/8	1/8 NPTF	0.669	0.157	1.043	1.929	0.374	0.531	0.591	0.512
INB	109E-308-021	3/8	1/4 NPTF	0.709	0.236	1.043	2.067	0.512	0.531	0.591	0.591
INB	109E-308-022	3/8	3/8 NPTF	0.748	0.315	1.043	2.106	0.512	0.531	0.591	0.709

INB110 Union Tee

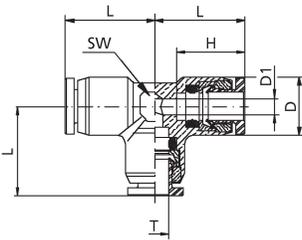

Brass Release Ring	INB110	Tube Diameter (T)	D	D1	L	H	SW
INB	110-108-000	1/8	0.394	0.094	0.638	0.472	0.354
INB	110-532-000	5/32	0.394	0.118	0.657	0.492	0.354
INB	110-104-000	1/4	0.472	0.157	0.740	0.531	0.433
INB	110-516-000	5/16	0.591	0.236	0.858	0.630	0.551
INB	110-308-000	3/8	0.709	0.295	1.004	0.669	0.630
INB	110-102-000	1/2	0.827	0.413	1.161	0.748	0.685

INB114 Swivel Branch Tee

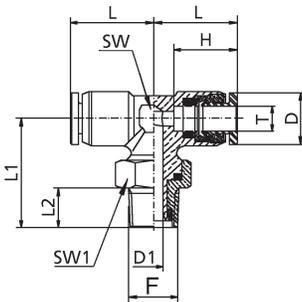

Brass Release Ring	INB114	Tube Diameter (T)	Thread (F)	D	D1	L	L1	L2	H	SW	SW1
INB	114-108-036	1/8	10-32 UNF	0.394	0.087	0.638	0.630	0.165	0.472	0.354	0.354
INB	114-108-020	1/8	1/8 NPTF	0.394	0.157	0.638	0.874	0.374	0.472	0.354	0.512
INB	114-108-021	1/8	1/4 NPTF	0.394	0.157	0.638	1.008	0.512	0.472	0.354	0.591
INB	114-532-036	5/32	10-32 UNF	0.394	0.087	0.657	0.630	0.165	0.492	0.354	0.354
INB	114-532-020	5/32	1/8 NPTF	0.394	0.157	0.657	0.874	0.374	0.492	0.354	0.512
INB	114-532-021	5/32	1/4 NPTF	0.394	0.157	0.657	1.008	0.512	0.492	0.354	0.591
INB	114-104-020	1/4	1/8 NPTF	0.472	0.157	0.740	0.996	0.374	0.531	0.433	0.512
INB	114-104-021	1/4	1/4 NPTF	0.472	0.236	0.740	1.142	0.512	0.531	0.433	0.591
INB	114-104-022	1/4	3/8 NPTF	0.472	0.236	0.740	1.181	0.512	0.531	0.433	0.709
INB	114-516-020	5/16	1/8 NPTF	0.591	0.157	0.925	0.984	0.374	0.630	0.551	0.512
INB	114-516-021	5/16	1/4 NPTF	0.591	0.236	0.925	1.122	0.512	0.630	0.551	0.591
INB	114-308-020	3/8	1/8 NPTF	0.709	0.157	1.043	1.043	0.374	0.669	0.630	0.709
INB	114-308-021	3/8	1/4 NPTF	0.709	0.236	1.043	1.181	0.512	0.669	0.630	0.591
INB	114-308-022	3/8	3/8 NPTF	0.709	0.315	1.043	1.220	0.512	0.699	0.630	0.709
INB	114-308-023	3/8	1/2 NPTF	0.709	0.315	1.043	1.394	0.709	0.699	0.630	0.866
INB	114-102-021	1/2	1/4 NPTF	0.827	0.236	1.181	1.299	0.512	0.748	0.685	0.591
INB	114-102-022	1/2	3/8 NPTF	0.827	0.315	1.181	1.299	0.512	0.748	0.685	0.709
INB	114-102-023	1/2	1/2 NPTF	0.827	0.315	1.181	1.476	0.709	0.748	0.685	0.866

### Dimensions: inches

### Dimensional Drawings - INB116 Swivel Run Tee

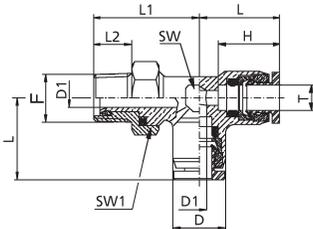

Brass Release Ring	INB116	Tube Diameter (T)	Thread (F)	D	D1	L	L1	L2	H	SW	SW1
INB	116-108-036	1/8	10-32 UNF	0.394	0.087	0.638	0.630	0.165	0.472	0.354	0.354
INB	116-108-020	1/8	1/8 NPTF	0.394	0.157	0.638	0.874	0.374	0.472	0.354	0.512
INB	116-108-021	1/8	1/4 NPTF	0.394	0.157	0.638	1.008	0.512	0.472	0.354	0.591
INB	116-532-036	5/32	10-32 UNF	0.394	0.087	0.657	0.630	0.165	0.492	0.354	0.354
INB	116-532-020	5/32	1/8 NPTF	0.394	0.157	0.657	0.874	0.374	0.492	0.354	0.512
INB	116-532-021	5/32	1/4 NPTF	0.394	0.157	0.657	1.008	0.512	0.492	0.354	0.591
INB	116-104-020	1/4	1/8 NPTF	0.472	0.157	0.740	0.996	0.374	0.531	0.433	0.512
INB	116-104-021	1/4	1/4 NPTF	0.472	0.236	0.740	1.142	0.512	0.531	0.433	0.591
INB	116-104-022	1/4	3/8 NPTF	0.472	0.236	0.740	1.181	0.512	0.531	0.433	0.709
INB	116-516-020	5/16	1/8 NPTF	0.591	0.157	0.925	0.984	0.374	0.630	0.551	0.512
INB	116-516-021	5/16	1/4 NPTF	0.591	0.236	0.925	1.122	0.512	0.630	0.551	0.591
INB	116-308-020	3/8	1/8 NPTF	0.709	0.157	1.043	1.043	0.374	0.669	0.630	0.512
INB	116-308-021	3/8	1/4 NPTF	0.709	0.236	1.043	1.181	0.512	0.669	0.630	0.591
INB	116-308-022	3/8	3/8 NPTF	0.709	0.315	1.043	1.220	0.512	0.699	0.630	0.709
INB	116-308-023	3/8	1/2 NPTF	0.709	0.315	1.043	1.394	0.709	0.699	0.630	0.866
INB	116-102-021	1/2	1/4 NPTF	0.827	0.236	1.181	1.299	0.512	0.748	0.685	0.591
INB	116-102-022	1/2	3/8 NPTF	0.827	0.315	1.181	1.299	0.512	0.748	0.685	0.709
INB	116-102-023	1/2	1/2 NPTF	0.827	0.315	1.181	1.476	0.709	0.748	0.685	0.866

### IN118 Plug

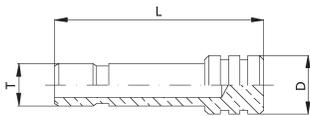

IN118	T	D	L
IN118-108-000	1/8	0.197	0.827
IN118-532-000	5/32	0.236	0.906
IN118-104-000	1/4	0.315	0.984
IN118-516-000	5/16	0.394	1.063
IN118-308-000	3/8	0.472	1.102
IN118-102-000	1/2	0.591	1.260

### IN119 Double Male Union

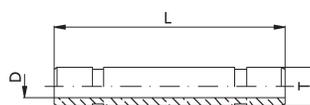

IN119	T	D	L
IN119-108-000	1/8	0.063	1.102
IN119-532-000	5/32	0.079	1.181
IN119-104-000	1/4	0.157	1.260
IN119-516-000	5/16	0.236	1.535
IN119-308-000	3/8	0.295	1.614
IN119-102-000	1/2	0.394	1.811

### Dimensions: inches

### Dimensional Drawings - IN120 Stem Adapter

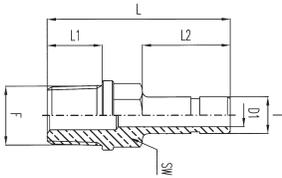

IN120	T	Thread (F)	D1	L	L1	L2	SW
IN120-108-020	1/8	1/8 NPTF	0.063	1.181	0.374	0.531	3/8
IN120-108-021	1/8	1/4 NPTF	0.063	1.358	0.512	0.531	1/2
IN120-532-020	5/32	1/8 NPTF	0.079	1.201	0.374	0.551	3/8
IN120-532-021	5/32	1/4 NPTF	0.079	1.378	0.512	0.551	1/2
IN120-104-020	1/4	1/8 NPTF	0.157	1.252	0.374	0.602	3/8
IN120-104-021	1/4	1/4 NPTF	0.157	1.429	0.512	0.602	1/2
IN120-516-020	5/16	1/8 NPTF	0.236	1.358	0.374	0.709	3/8
IN120-516-021	5/16	1/4 NPTF	0.236	1.535	0.512	0.709	1/2
IN120-308-021	3/8	1/4 NPTF	0.276	1.654	0.512	0.827	1/2
IN120-308-022	3/8	3/8 NPTF	0.276	1.673	0.512	0.827	19/32
IN120-102-022	1/2	3/8 NPTF	0.394	1.752	0.512	0.906	19/32
IN120-102-023	1/2	1/2 NPTF	0.394	1.949	0.709	0.906	11/16

### INB121 Reducer

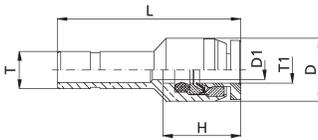

Brass Release Ring	INB121	T	T1	D	D1	L	H
INB	121-104-108	1/4	1/8	0.394	0.094	1.082	0.472
INB	121-104-532	1/4	5/32	0.394	0.118	1.142	0.492
INB	121-308-104	3/8	1/4	0.472	0.157	1.339	0.531
INB	121-102-104	1/2	1/4	0.472	0.157	1.417	0.531
INB	121-102-308	1/2	3/8	0.669	0.295	1.673	0.669

### INB122 Single Banjo

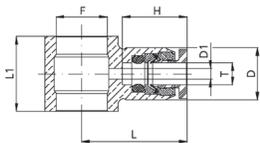

Brass Release Ring	INB122	Tube Diameter (T)	Thread (F)	D	D1	L	L1	H
INB	122-532-036	5/32	10-32 UNF	0.394	0.110	0.748	0.472	0.492
INB	122-532-020	5/32	1/8 NPTF	0.394	0.118	0.795	0.571	0.492
INB	122-308-021	3/8	1/4 NPTF	0.709	0.295	1.067	0.709	0.669

### INB123 Double Banjo

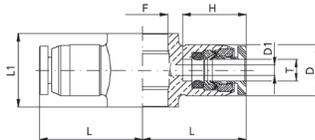

Brass Release Ring	INB123	Tube Diameter (T)	Thread (F)	D	D1	L	L1	H
INB	123-532-036	5/32	10-32 UNF	0.394	0.118	0.748	0.472	0.492
INB	123-104-020	1/4	1/8 NPTF	0.472	0.157	0.811	0.571	0.531
INB	123-104-021	1/4	1/4 NPTF	0.472	0.157	0.890	0.689	0.531
INB	123-308-021	3/8	1/4 NPTF	0.709	0.295	1.067	0.709	0.669

Dimensions: inches

### Dimensional Drawings - IN124 Single Manifold

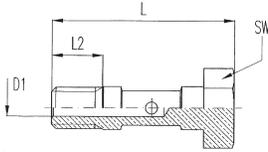

IN124	Thread (F)	D1	L	L2	SW	SW1
IN124-000-036	10-32 UNF	0.079	0.827	0.223	0.315	-
IN124-000-020	1/8 NPTF	0.197	1.634	0.374	0.551	0.551
IN124-000-021	1/4 NPTF	0.276	2.067	0.512	0.669	0.669

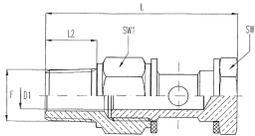

### IN125 Double Manifold

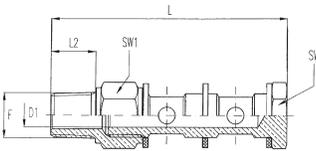

IN125	Thread (F)	D1	L	L2	SW	SW1
IN125-000-020	1/8 NPTF	0.197	2.187	0.374	0.551	0.551
IN125-000-021	1/4 NPTF	0.276	2.715	0.512	0.669	0.669

### INB131 Union Y

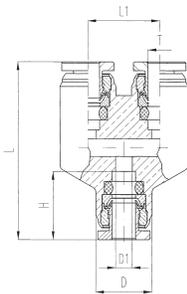

Brass Release Ring	INB131	Tube Diameter (T)	D	D1	L	L1	H
INB	131-108-000	1/8	0.394	0.094	1.240	0.512	0.472
INB	131-532-000	1/8	0.394	0.118	1.280	0.512	0.492
INB	131-104-000	5/32	0.472	0.157	1.398	0.598	0.531

### INB132 Male Y

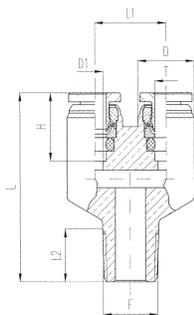

Brass Release Ring	INB132	Tube Diameter (T)	Thread (F)	D	D1	L	L1	L2	H
INB	132-108-020	1/8	1/8 NPTF	0.394	0.094	1.339	0.512	0.374	0.472
INB	132-532-020	5/32	1/8 NPTF	0.394	0.118	1.350	0.512	0.374	0.492
INB	132-104-020	1/4	1/8 NPTF	0.394	0.094	1.319	0.512	0.165	0.472

How to Order

Metric Fittings

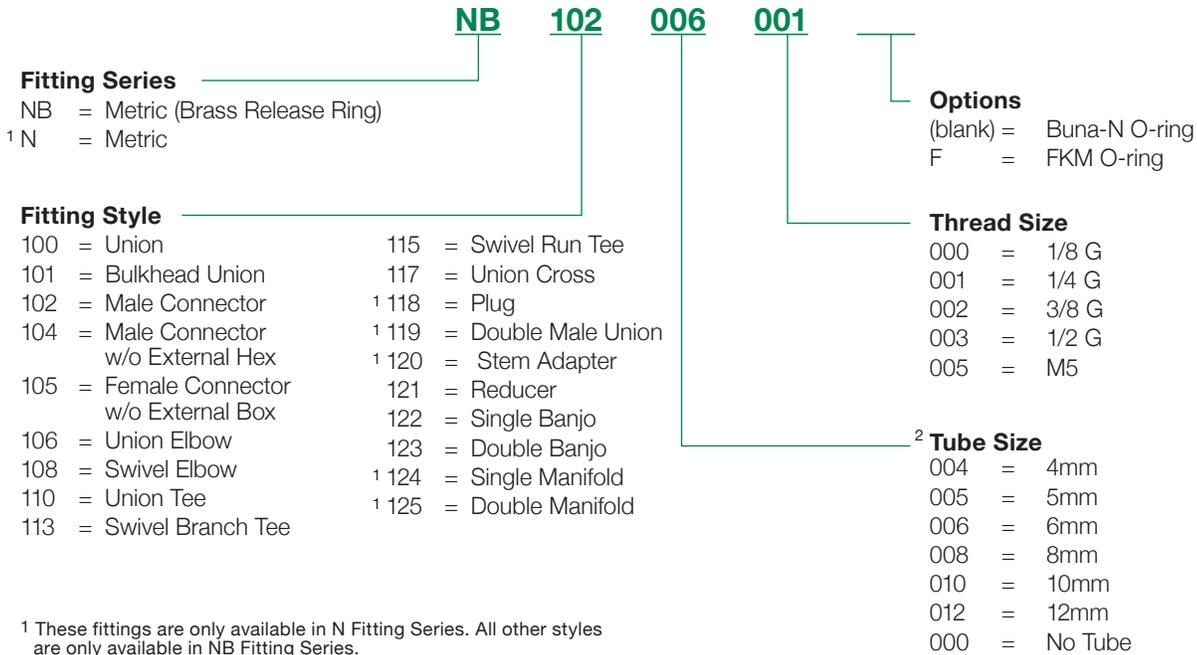

<sup>1</sup> These fittings are only available in N Fitting Series. All other styles are only available in NB Fitting Series.

<sup>2</sup> See Fitting Style Charts on pages 15 – 19 for available Tube and Thread Configurations.

- Pressure Rating to 265 psi
- Temperature Range:  
 -20 °F to 176 °F (Buna-N O-ring)  
 -20 °F to 230 °F (FKM O-ring)
- Push-in fittings with G threads
- Tube Diameter: 4mm to 12mm
- Thread Size: M5 to 1/2 G

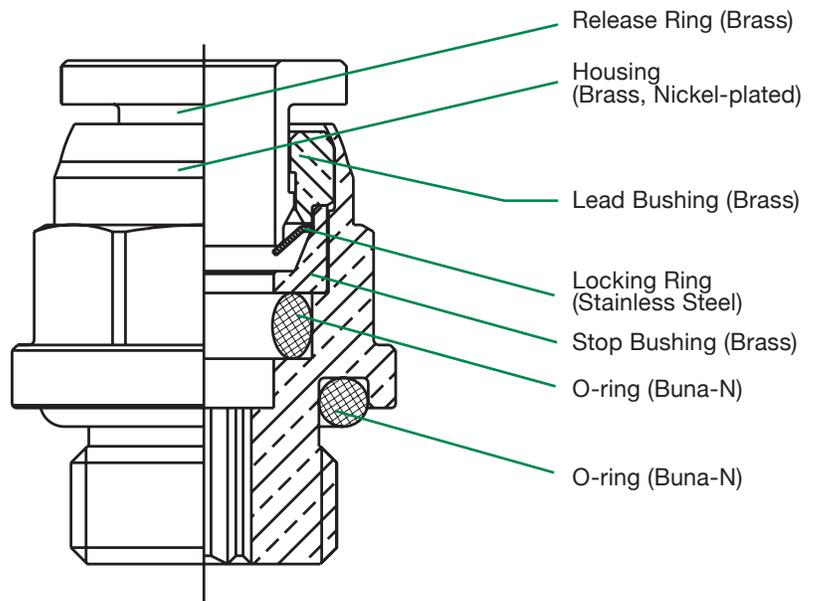



Dimensions: mm

### Dimensional Drawings - NB100 Union

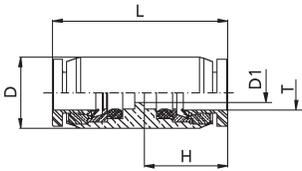

NB100	Tube Diameter (T)	D	D1	L	H
NB100-004-000	4.0	10.0	2.0	26.0	12.2
NB100-005-000	5.0	11.0	3.0	27.0	12.7
NB100-006-000	6.0	12.0	4.0	28.0	13.3
NB100-008-000	8.0	15.0	6.0	33.0	15.8
NB100-010-000	10.0	18.0	8.0	35.5	16.8
NB100-012-000	12.0	20.0	10.0	41.0	18.9

### NB101 Bulkhead Union

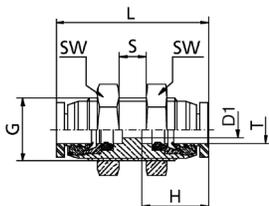

NB101	Tube Diameter (T)	External Thread (G)	D1	L	H	Min. S	Max. S	SW
NB101-004-000	4.0	M11	2.0	28.7	12.2	0	6	14
NB101-005-000	5.0	M12	3.0	29.2	12.7	0	6	15
NB101-006-000	6.0	M13	4.0	31.6	13.3	0	8	16
NB101-008-000	8.0	M16	6.0	36.5	15.8	0	8	19
NB101-010-000	10.0	M19	8.0	41.6	16.8	0	11	22
NB101-012-000	12.0	M22	10.0	48.0	18.9	0	15	26

### NB102 Male Connector

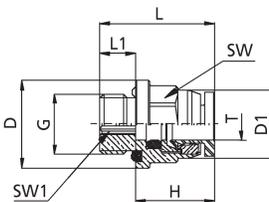

NB102	Tube Diameter (T)	Thread (G)	D	D1	L	L1	H	SW	SW1
NB102-004-000	4.0	1/8	14.0	9.9	18.1	5.7	12.2	10	3
NB102-004-001	4.0	1/4	17.0	9.9	18.8	6.0	12.2	10	3
NB102-005-000	5.0	1/8	14.0	10.9	18.8	5.7	12.7	11	3
NB102-005-001	5.0	1/4	17.0	10.9	19.2	6.0	12.7	11	3
NB102-006-000	6.0	1/8	14.0	11.9	19.0	5.7	13.3	12	4
NB102-006-001	6.0	1/4	17.0	11.9	19.8	6.0	13.3	12	4
NB102-008-000	8.0	1/8	17.0	15.0	24.5	5.7	15.8	15	6
NB102-008-001	8.0	1/4	19.0	15.0	22.0	6.0	15.8	16	6
NB102-008-002	8.0	3/8	21.0	15.0	22.7	6.5	15.8	16	6
NB102-010-001	10.0	1/4	20.0	17.4	25.3	6.0	16.8	18	7
NB102-010-002	10.0	3/8	22.0	17.4	23.3	6.5	16.8	18	7
NB102-010-003	10.0	1/2	26.0	17.4	28.3	9.5	16.8	18	7
NB102-012-001	12.0	1/4	22.0	20.0	27.4	6.0	18.9	20	7
NB102-012-002	12.0	3/8	22.0	20.0	28.0	6.0	18.9	20	7
NB102-012-003	12.0	1/2	26.0	20.0	31.5	9.5	18.9	20	9

### NB104 Male Connector without External Hex

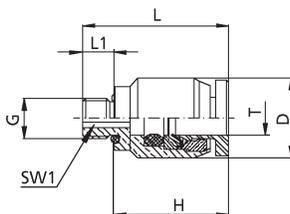

NB104	Tube Diameter (T)	Thread (G)	D	L	L1	H	SW1
NB104-004-005	4.0	M5	10.0	18.4	4.0	14.4	2
NB104-005-005	5.0	M5	11.0	18.7	4.0	14.7	2
NB104-006-005	6.0	M5	12.0	19.3	4.0	15.3	2

Dimensions: mm

### Dimensional Drawings - NB105 Female Connector without External Box

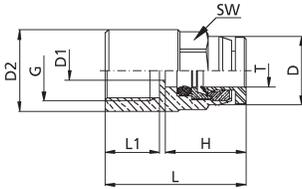

NB105	Tube Diameter (T)	Thread (G)	D	D1	D2	L	L1	H	SW
NB105-004-005	4.0	M5	9.9	2.0	8.0	19.4	5.5	12.2	10
NB105-004-000	4.0	1/8	9.9	2.0	12.0	22.4	8.5	12.2	10
NB105-005-005	5.0	M5	10.9	3.0	8.0	19.7	5.5	12.7	11
NB105-005-001	5.0	1/4	10.9	3.0	17.0	24.7	10.5	12.7	11
NB105-006-000	6.0	1/8	11.9	4.0	12.0	23.3	8.5	13.3	12
NB105-006-001	6.0	1/4	11.9	4.0	17.0	25.3	10.5	13.3	12
NB105-008-000	8.0	1/8	15.0	6.0	12.0	25.8	8.5	15.8	15
NB105-008-001	8.0	1/4	15.0	6.0	17.0	28.3	10.5	15.8	15
NB105-010-001	10.0	1/4	17.4	8.0	17.0	29.3	10.5	16.8	18
NB105-010-002	10.0	3/8	17.4	8.0	20.0	30.3	11.5	16.8	18
NB105-012-001	12.0	1/4	20.0	10.0	22.0	32.0	10.5	18.9	20
NB105-012-002	12.0	3/8	20.0	10.0	22.0	33.0	11.5	18.9	20
NB102-012-003	12.0	1/2	20.0	10.0	26.0	37.4	16.0	18.9	20

### NB106 Union Elbow

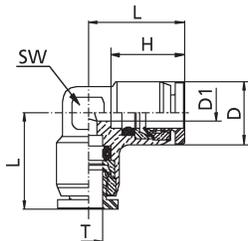

NB106	Tube Diameter (T)	D	D1	L	H	SW
NB106-004-000	4.0	9.9	2.0	16.6	12.2	9
NB106-005-000	5.0	10.9	3.0	16.6	12.7	10
NB106-006-000	6.0	11.9	4.0	19.1	13.3	11
NB106-008-000	8.0	15.0	6.0	21.8	15.8	14
NB106-010-001	10.0	17.4	8.0	25.3	16.8	16
NB106-012-000	12.0	20.4	10.0	29.1	18.9	17

### NB108 Swivel Elbow

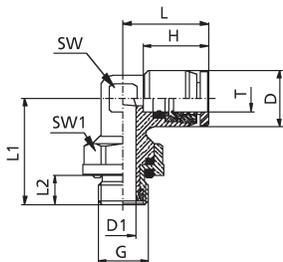

NB108	Tube Diameter (T)	Thread (G)	D	D1	L	L1	L2	H	SW	SW1
NB108-004-005	4.0	M5	9.9	2.3	16.6	16.5	4.0	12.2	9	9
NB108-004-000	4.0	1/8	9.9	4.0	16.6	19.8	5.7	12.2	9	13
NB108-004-001	4.0	1/4	9.9	4.0	16.6	20.0	6.0	12.2	9	15
NB108-005-005	5.0	M5	10.9	2.3	16.6	18.0	4.0	12.7	10	9
NB108-005-000	5.0	1/8	10.9	4.0	16.6	20.0	5.7	12.7	10	13
NB108-005-001	5.0	1/4	10.9	4.0	16.6	20.2	6.0	12.7	10	15
NB108-006-005	6.0	M5	11.9	2.3	19.1	18.5	4.0	13.3	11	9
NB108-006-000	6.0	1/8	11.9	4.0	19.1	20.9	5.7	13.3	11	13
NB108-006-001	6.0	1/4	11.9	6.0	19.1	21.0	6.0	13.3	11	15
NB108-008-000	8.0	1/8	15.0	4.0	23.3	22.7	5.7	15.8	14	13
NB108-008-001	8.0	1/4	15.0	6.0	23.3	22.7	6.0	15.8	14	15
NB108-008-002	8.0	3/8	15.0	8.0	23.3	25.2	6.5	15.8	14	18
NB108-010-000	10.0	1/8	17.4	4.0	26.5	24.0	5.7	16.8	16	13
NB108-010-001	10.0	1/4	17.4	6.0	26.5	24.1	6.0	16.8	16	15
NB108-010-002	10.0	3/8	17.4	8.0	26.5	26.4	6.5	16.8	16	18
NB108-010-003	10.0	1/2	17.4	8.0	26.5	30.4	9.5	16.8	16	18
NB108-012-001	12.0	1/4	20.0	6.0	29.1	27.3	6.0	18.9	17	15
NB108-012-002	12.0	3/8	20.0	8.0	29.1	29.5	6.5	18.9	17	18
NB108-012-003	12.0	1/2	20.0	8.0	29.1	33.5	9.5	18.9	17	18

Dimensions: mm

### Dimensional Drawings - NB110 Union Tee

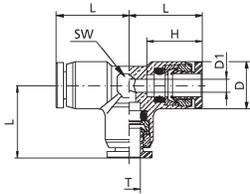

NB110	Tube Diameter (T)	D	D1	L	H	SW
NB110-004-000	4.0	9.9	2.0	16.6	12.2	9
NB110-005-000	5.0	10.9	3.0	16.6	12.7	10
NB110-006-000	6.0	11.9	4.0	19.1	13.3	11
NB110-008-000	8.0	15.0	6.0	21.8	15.8	14
NB110-010-000	10.0	17.4	8.0	25.3	16.8	16
NB110-012-000	12.0	20.4	10.0	29.1	18.9	17

### NB113 Swivel Branch Tee

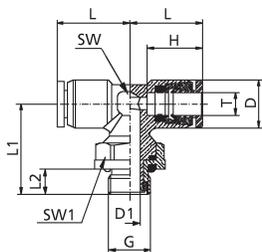

NB113	Tube Diameter (T)	Thread (G)	D	D1	L	L1	L2	H	SW	SW1
NB113-004-000	4.0	1/8	9.9	4.0	16.6	19.8	5.7	12.2	9	13
NB113-006-000	6.0	1/8	11.9	4.0	19.1	20.9	5.7	13.3	11	13
NB113-006-001	6.0	1/4	11.9	6.0	19.1	21.5	6.0	13.3	11	15
NB113-008-000	8.0	1/8	15.0	4.0	23.3	22.7	5.7	15.8	14	13
NB113-008-001	8.0	1/4	15.0	6.0	23.3	22.7	6.0	15.8	14	15
NB113-008-002	8.0	3/8	15.0	8.0	23.3	25.2	6.5	15.8	14	18
NB113-010-001	10.0	1/4	17.4	6.0	26.5	24.1	6.0	16.8	16	15
NB113-010-002	10.0	3/8	17.4	8.0	26.5	26.4	6.5	16.8	16	18
NB113-010-003	10.0	1/2	17.4	8.0	26.5	30.4	9.0	16.8	16	18
NB113-012-001	12.0	1/4	20.0	6.0	29.1	27.3	6.0	18.9	17	15
NB113-012-002	12.0	3/8	20.0	8.0	29.1	29.5	6.5	18.9	17	18
NB113-012-003	12.0	1/2	20.0	8.0	29.1	33.5	8.5	18.9	17	18

### NB115 Swivel Run Tee

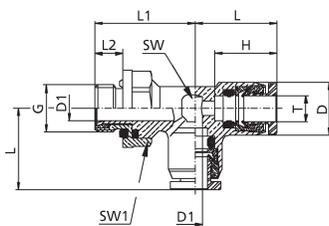

NB115	Tube Diameter (T)	Thread (G)	D	D1	L	L1	L2	H	SW	SW1
NB115-004-000	4.0	1/8	9.9	4.0	16.6	19.8	5.7	12.2	9	13
NB115-005-000	5.0	1/8	10.9	4.0	16.6	20.0	5.7	12.7	10	13
NB115-006-000	6.0	1/8	11.9	4.0	19.1	20.9	5.7	13.3	11	13
NB115-006-001	6.0	1/4	11.9	6.0	19.1	21.5	6.0	13.3	11	15
NB115-008-000	8.0	1/8	15.0	4.0	23.3	22.7	5.7	15.8	14	13
NB115-008-001	8.0	1/4	15.0	6.0	23.3	22.7	6.0	15.8	14	15
NB115-008-002	8.0	3/8	15.0	8.0	23.3	25.2	6.5	15.8	14	18
NB115-010-001	10.0	1/4	17.4	6.0	26.5	24.1	6.0	16.8	16	15
NB115-010-002	10.0	3/8	17.4	8.0	26.5	26.4	6.5	16.8	16	18
NB115-010-003	10.0	1/2	17.4	8.0	26.5	30.4	9.5	16.8	16	18
NB115-012-002	12.0	3/8	20.0	8.0	29.1	29.5	6.5	18.9	17	18
NB115-012-003	12.0	1/2	20.0	8.0	29.1	33.5	9.5	18.9	17	18

### NB117 Union Cross

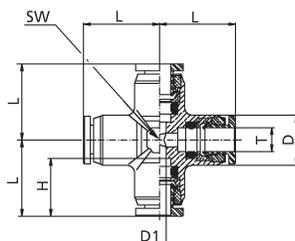

NB117	Tube Diameter (T)	D	D1	L	H	SW
NB117-004-000	4.0	9.9	2.0	16.6	12.2	9
NB117-005-000	5.0	10.9	3.0	16.6	12.7	10
NB117-006-000	6.0	11.9	4.0	19.1	13.3	11
NB117-008-000	8.0	15.0	6.0	21.8	15.8	14
NB117-010-000	10.0	17.4	8.0	25.3	16.8	16
NB117-012-000	12.0	20.4	10.0	29.1	18.9	17

Dimensions: mm

### Dimensional Drawings - N118 Plug

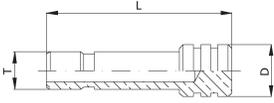

N118	Tube Diameter (T)	D	L
N118-004-000	4.0	6.0	23.1
N118-005-000	5.0	7.0	25.1
N118-006-000	6.0	8.0	25.1
N118-008-000	8.0	10.0	27.1
N118-010-000	10.0	12.0	28.1
N118-012-000	12.0	14.0	32.0

### N119 Double Male Union

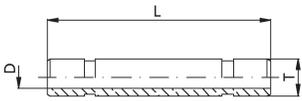

N119	Tube Diameter (T)	D	L
N119-004-000	4.0	2.0	30.0
N119-006-000	6.0	4.0	32.0
N119-008-000	8.0	6.0	38.0
N119-010-000	10.0	8.0	41.0
N119-012-000	12.0	10.0	46.0

### N120 Stem Adapter

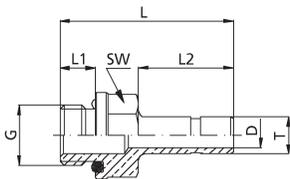

N120	Tube Diameter (T)	Thread (G)	D	L	L1	L2	SW
N120-004-005	4.0	M5	2.0	23.0	4.0	14.0	9
N120-004-000	4.0	1/8	2.0	26.7	5.7	14.0	12
N120-004-001	4.0	1/4	2.0	27.0	6.0	14.0	15
N120-005-000	5.0	1/8	3.0	27.7	5.7	15.0	12
N120-006-005	6.0	M5	2.0	24.3	4.0	15.3	9
N120-006-000	6.0	1/8	4.0	28.0	5.7	15.3	12
N120-006-001	6.0	1/4	4.0	28.3	6.0	15.3	15
N120-008-000	8.0	1/8	6.0	30.7	5.7	18.0	12
N120-008-001	8.0	1/4	6.0	31.0	6.0	18.0	15
N120-010-001	10.0	1/4	8.0	34.0	6.0	21.0	15
N120-010-002	10.0	3/8	8.0	35.0	6.5	21.0	18
N120-010-003	10.0	1/2	8.0	40.0	9.5	21.0	18
N120-012-001	12.0	1/4	10.0	36.0	6.0	23.0	15
N120-012-003	12.0	1/2	10.0	42.0	9.5	23.0	18

### NB121 Reducer

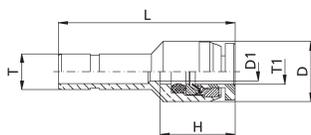

NB121	From Tube Diameter (T)	To Tube Diameter (T1)	D	D1	L	H
NB121-005-000	5.0	4.0	10.0	3.0	28.2	12.2
NB121-006-000	6.0	4.0	10.0	3.0	29.2	12.2
NB121-006-001	6.0	5.0	11.0	3.0	29.6	12.7
NB121-008-000	8.0	4.0	10.0	2.0	32.2	12.2
NB121-008-001	8.0	5.0	11.0	3.0	32.5	12.7
NB121-008-002	8.0	6.0	12.0	4.0	33.1	13.3
NB121-010-002	10.0	6.0	12.0	4.0	25.9	13.3
NB121-010-003	10.0	8.0	15.0	6.0	38.3	15.8
NB121-012-002	12.0	6.0	12.0	4.0	36.3	13.3
NB121-012-003	12.0	8.0	15.0	6.0	40.3	15.8
NB121-012-004	12.0	10.0	18.0	8.0	42.8	16.8

Dimensions: mm

### Dimensional Drawings - NB122 Single Banjo

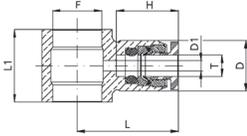

NB122	Tube Diameter (T)	For Banjo Bolts (A)	D	D1	L	L1	H
NB122-004-000	4.0	1/8	10.0	2.0	20.2	14.5	12.2
NB122-006-005	6.0	M5	12.0	4.0	20.6	12.0	13.3
NB122-006-000	6.0	1/8	12.0	4.0	20.6	14.5	13.3
NB122-006-001	6.0	1/4	12.0	4.0	22.6	14.5	13.3
NB122-008-000	8.0	1/8	15.0	6.0	23.8	17.5	15.8
NB122-008-001	8.0	1/4	15.0	6.0	25.8	17.5	15.8
NB122-010-001	10.0	1/4	17.6	8.0	27.1	18.0	16.8

### NB123 Double Banjo

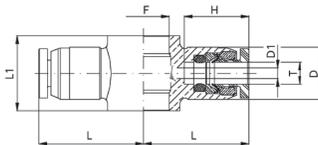

NB123	Tube Diameter (T)	For Banjo Bolts (A)	D	D1	L	L1	H
NB123-004-005	4.0	M5	10.0	2.0	19.0	12.0	12.2
NB123-004-000	4.0	1/8	10.0	2.0	20.2	14.5	12.2
NB123-006-005	6.0	M5	12.0	4.0	20.6	12.0	13.3
NB123-006-000	6.0	1/8	12.0	4.0	20.6	14.5	13.3
NB123-006-001	6.0	1/4	12.0	4.0	22.6	14.5	13.3
NB123-008-001	8.0	1/4	15.0	6.0	25.8	17.5	15.8

### N124 Single Manifold

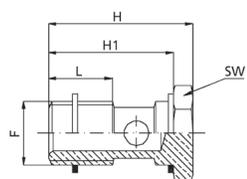

N124	Thread (F)	D1	L	L2	SW	SW1
N124-000-036	10-32 UNF	0.079	0.827	0.223	0.315	-
N124-004-000	1/8 NPTF	0.197	1.634	0.374	0.551	0.551
N124-000-001	1/4 NPTF	0.276	2.067	0.512	0.669	0.669

### N125 Double Manifold

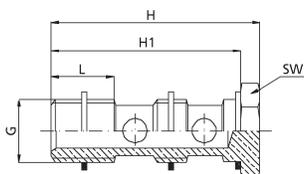

N125	Thread (G)	L	H	H1	SW
N125-000-000	1/8	8.0	43.0	39.0	14
N125-000-001	1/4	11.0	45.5	41.0	17

Dimensions: inches

Dimensional Drawings - INWB1391C World Thread™ Flow Control/Inch Tube

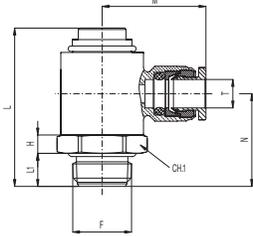

Brass Release Ring	INWB1391C	Tube Diameter (T)	Thread (F)	L	L1	M	N	H	CH.1
INB	1391C-108-020	1/8	1/8	42.4	4.9	20.5	24.0	6	14
INB	1391C-532-020	5/32	1/8	42.4	4.9	21.0	24.0	6	14
INB	1391C-104-020	1/4	1/8	42.4	4.9	21.5	24.0	6	14
INB	1391C-104-021	1/4	1/4	37.5	7.2	23.0	23.2	7	17
INB	1391C-516-021	5/16	1/4	37.5	7.2	26.0	23.2	7	17
INB	1391C-308-021	3/8	1/4	37.5	7.2	27.5	23.2	7	17
INB	1391C-516-022	5/16	3/8	42.2	7.6	28.0	26.0	8	20
INB	1391C-308-022	3/8	3/8	42.2	7.6	29.5	26.0	8	20

INWB139C World Thread™ Flow Control with Knob/Inch Tube

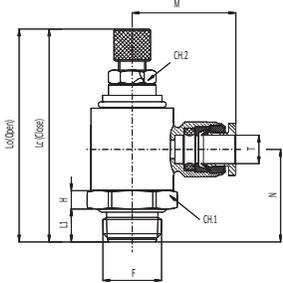

Brass Release Ring	INWB139C	Tube Diameter (T)	Thread (F)	Lc	Lo	L1	M	N	H	CH.1	CH.2
INB	139C-108-020	1/8	1/8	54.5	61.0	4.9	20.5	24.0	6	14	7
INB	139C-532-020	5/32	1/8	54.5	61.0	4.9	21.0	24.0	6	14	7
INB	139C-104-020	1/4	1/8	54.5	61.0	4.9	21.5	24.0	6	14	7
INB	139C-104-021	1/4	1/4	50.0	54.5	7.2	23.0	23.2	7	17	9
INB	139C-516-021	5/16	1/4	50.0	54.5	7.2	26.0	23.2	7	17	9
INB	139C-308-021	3/8	1/4	50.0	54.5	7.2	27.5	23.2	7	17	9
INB	139C-516-022	5/16	3/8	56.8	60.3	7.6	28.0	26.0	8	20	11
INB	139C-308-022	3/8	3/8	56.8	60.3	7.6	29.5	26.0	8	20	11

Dimensions: mm

Dimensional Drawings - NWB1391C World Thread™ Flow Control/Metric Tube

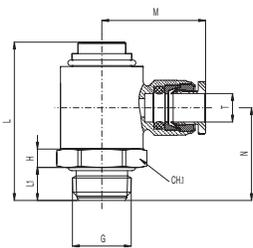

NWB1391C	Tube Diameter (T)	Thread (G)	L	L1	M	N	H	CH.1
NWB1391C-004-020	4mm	1/8	42.4	4.9	20.5	24.0	6	14
NWB1391C-006-020	6mm	1/8	42.4	4.9	21.0	24.0	6	14
NWB1391C-006-021	6mm	1/4	37.5	7.2	23.0	23.2	7	17
NWB1391C-008-021	8mm	1/4	37.5	7.2	26.5	23.2	7	17
NWB1391C-010-021	10mm	1/4	37.5	7.2	27.5	23.2	7	17
NWB1391C-008-022	8mm	3/8	42.2	7.6	28.0	26.0	8	20
NWB1391C-010-022	10mm	3/8	42.2	7.6	29.5	26.0	8	20

NWB139C World Thread™ Flow Control with Knob/Metric Tube

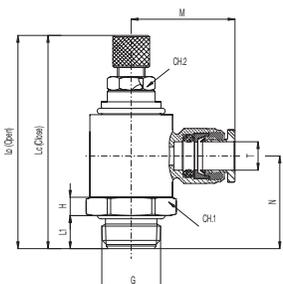

NWB139C	Tube Diameter (T)	Thread (G)	Lc	Lo	L1	M	N	H	CH.1	CH.2
NWB139C-004-020	4mm	1/8	54.5	61.0	4.9	20.5	24.0	6	14	7
NWB139C-006-020	6mm	1/8	54.5	61.0	4.9	21.0	24.0	6	14	7
NWB139C-006-021	6mm	1/4	50.0	54.5	7.2	23.0	23.2	7	17	9
NWB139C-008-021	8mm	1/4	50.0	54.5	7.2	26.5	23.2	7	17	9
NWB139C-010-021	10mm	1/4	50.0	54.5	7.2	27.5	23.2	7	17	9
NWB139C-008-022	8mm	3/8	56.8	60.3	7.6	28.0	26.0	8	20	11
NWB139C-010-022	10mm	3/8	56.8	60.3	7.6	29.5	26.0	8	20	11

### OEM Flow Controls

#### Features

Knob adjust, Screwdriver adjust

#### Specifications

Temperature Range: 0 °F to 176 °F

Maximum Operating Pressure: 265 psi

#### Materials of Construction

Body: Brass, Nickel-plated

Screw: Stainless Steel

Seals: Buna-N

Release Button: Oil or Brass

Adjustment Needle: Brass

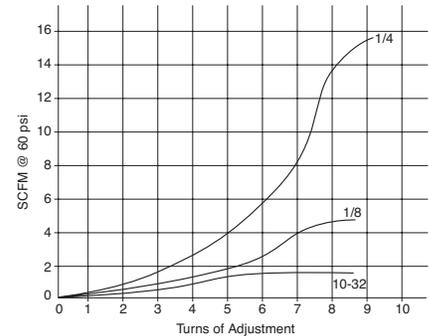
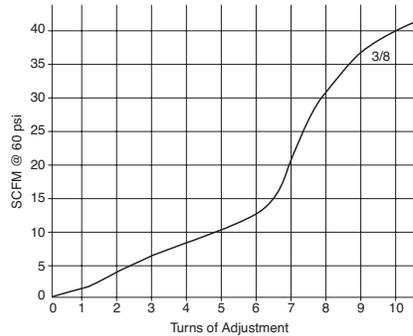

### Dimensions: inches

### Dimensional Drawings - INB135C Flow Control

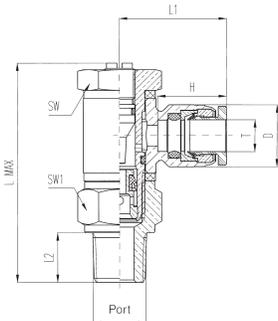

Brass Release Ring	INB135C	Tube Diameter (T)	Ports NPTF	D	L MAX	L1	L2	H	SW	SW1
INB	135C-108-036	1/8	10-32	0.394	0.945	0.748	0.217	0.472	0.315	-
INB	135C-108-020	1/8	1/8	0.394	1.665	0.748	0.374	0.472	0.551	0.551
INB	135C-532-036	5/32	10-32	0.394	0.945	0.748	0.217	0.492	0.315	-
INB	135C-532-020	5/32	1/8	0.394	1.673	0.795	0.374	0.492	0.551	0.551
INB	135C-104-020	1/4	1/8	0.472	1.673	0.881	0.374	0.531	0.551	0.551
INB	135C-104-021	1/4	1/4	0.472	2.126	0.890	0.512	0.531	0.669	0.669
INB	135C-308-021	3/8	1/4	0.709	2.126	1.067	0.512	0.669	0.669	0.669
INB	135C-308-022	3/8	3/8	0.709	2.333	1.220	0.512	0.669	0.748	0.866

### INB136C Flow Control with Knob

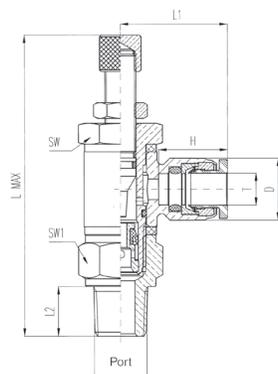

Brass Release Ring	INB136C	Tube Diameter (T)	Ports NPTF	D	L MAX	L1	L2	H	SW	SW1
INB	136C-108-036	1/8	10-32	0.394	0.945	0.748	0.217	0.472	0.315	-
INB	136C-108-020	1/8	1/8	0.394	1.665	0.748	0.374	0.472	0.551	0.551
INB	136C-532-036	5/32	10-32	0.394	0.945	0.748	0.217	0.492	0.315	-
INB	136C-532-020	5/32	1/8	0.394	1.673	0.795	0.374	0.492	0.551	0.551
INB	136C-104-020	1/4	1/8	0.472	1.673	0.881	0.374	0.531	0.551	0.551
INB	136C-104-021	1/4	1/4	0.472	2.126	0.890	0.512	0.531	0.669	0.669
INB	136C-308-021	3/8	1/4	0.709	2.126	1.067	0.512	0.669	0.669	0.669
INB	136C-308-022	3/8	3/8	0.709	2.333	1.220	0.512	0.669	0.748	0.866

## ACCESSORIES

### Flow Controls

#### Features

Body swivels 360°, provides accurate speed control in a compact size and eliminates need for fitting

#### Specifications

Temperature Range: 0 °F to 160 °F  
Maximum Operating Pressure: 175 psi (12 bar)

#### Materials of Construction

Body: Anodized Aluminum  
Cartridge: Nickel-plated Brass  
Screw: Stainless Steel  
Spring: Stainless Steel  
Seals: Buna-N

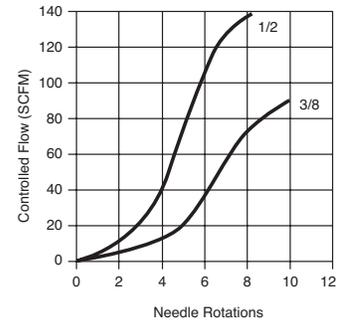
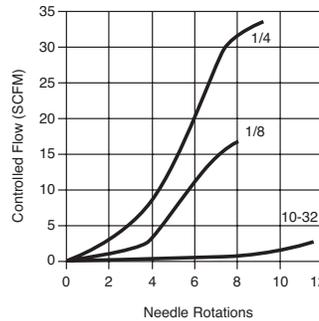

### Dimensions: inches

#### Dimensional Drawings - Standard Flow Control (with and without Push-in Fitting)

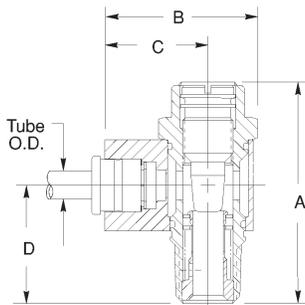

Ports NPTF	Without Push-in	With Push-in	Tube Diameter (Tube O.D.)	A	B	C	D
10-32	0FCRN	0FPRN4 0FPRN5	1/8 5/32	0.81	0.62	0.43	0.38
1/8	1FCRN	1FPRN8 1FPRN5	1/4 5/32	1.41	0.98	0.65	0.79
1/4	2FCRN	2FPRN8 2FPRN12	1/4 3/8	1.7	1.28	0.91	1.07
3/8	3FCRN	3FPRN12 3FPRN16	3/8 1/2	2.19	1.45	1.02	1.15
1/2	4FCRN	4FPRN12 4FPRN16	3/8 1/2	2.74	1.84	1.28	1.47

#### Knob Adjust Flow Control (with and without Push-in Fitting)

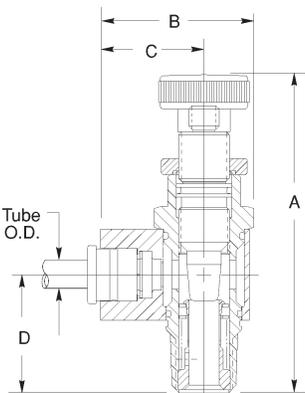

Ports NPTF	Without Push-in	With Push-in	Tube Diameter (Tube O.D.)	A	B	C	D
10-32	0FCTN	0FPTN4 0FPTN5	1/8 5/32	1.21	0.62	0.43	0.69
1/8	1FCTN	1FPTN8 1FPTN5	1/4 5/32	2.21	0.98	0.65	1.00
1/4	2FCTN	2FPTN8 2FPTN12	1/4 3/8	2.50	1.28	0.91	1.03
3/8	3FCTN	3FPTN12 3FPTN16	3/8 1/2	3.23	1.45	1.02	1.30
1/2	4FCTN	4FPTN12 4FPTN16	3/8 1/2	3.96	1.84	1.28	1.40

### How to Order

#### Metric Flow Controls

Change N to G in part number for BSPP thread or tube option.  
For example, change 0FCTN to 0FCTG or change 0FTPTN4 to 0FTPTG4.



Dimensions: inches

### Dimensional Drawings - 1FC1 Inline Flow Control

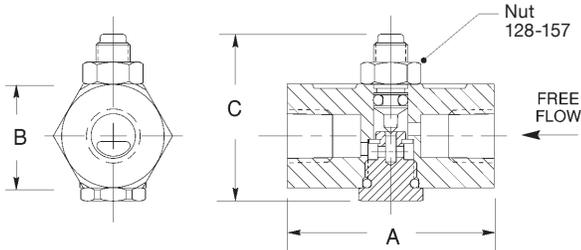

Ports NPTF	Without Knurled Knob	With Knurled Knob	Cv	A	B	C	D
1/8	1FC1	1FC1K	0.22	1.50	0.75	1.08	1.66
1/4	2FC1	2FC1K	0.22	1.50	0.75	1.08	1.66

Optional Knurled Knob (suffix K)

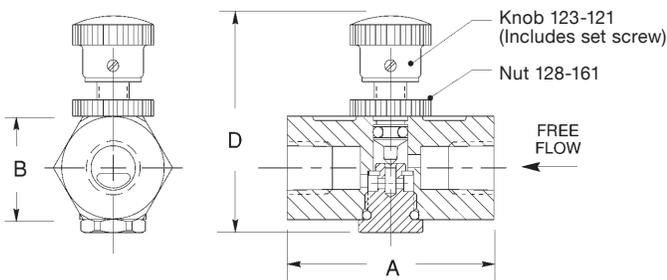

### FC2 Inline Flow Control

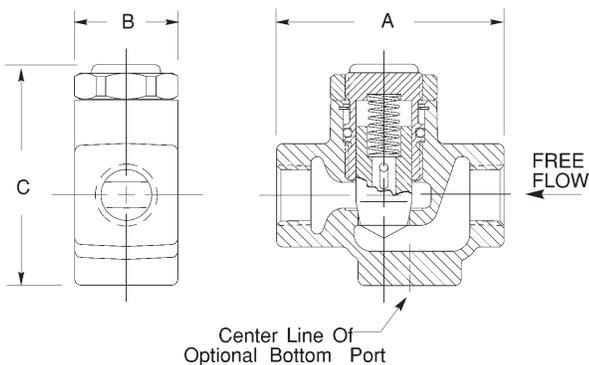

Ports NPTF	Without Bottom Port	With Bottom Port	Cv	A	B	C
1/4	2FC2	2FC2B	2.3	2.34	1.06	2.21
3/8	3FC2	3FC2B	2.7	2.34	1.06	2.21

Ports NPTF	Without Bottom Port	With Bottom Port	Cv	A	B	C
1/2	4FC3	4FC3B	6.0	3.28	1.50	3.17
3/4	5FC3	5FC3B	7.5	3.28	1.50	3.17

Dimensions: inches

Dimensional Drawings - Pilot Operated Check Valves

- NPTF threads have thread sealant applied
- Temperature Range: 15 °F to 160 °F
- Operating Pressure Range: 15 psi to 150 psi

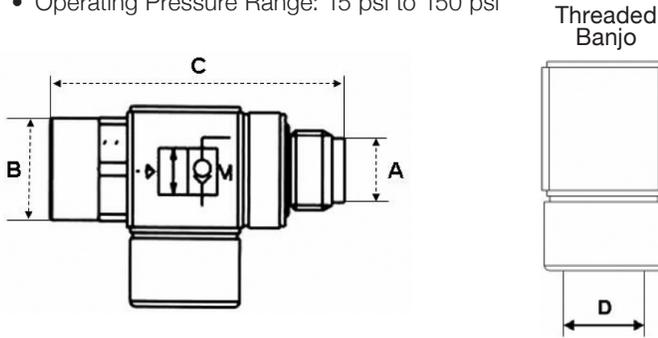

Part Number	A	B	C	Max. Tightening Torque		D	Pilot Port
NCPGG-020-020	1/8" NPTF	SW13	1.164	7 Nm	5.1 lbs/ft	1/8" NPTF	10-32 UNF
NCPGG-021-021	1/4" NPTF	SW17	1.890	15 Nm	11.0 lbs/ft	1/4" NPTF	10-32 UNF
NCPGG-022-022	3/8" NPTF	SW22	2.165	20 Nm	14.7 lbs/ft	3/8" NPTF	1/8" NPTF
NCPGG-023-023	1/2" NPTF	SW27	2.579	20 Nm	14.7 lbs/ft	1/2" NPTF	1/8" NPTF

Flow Characteristics

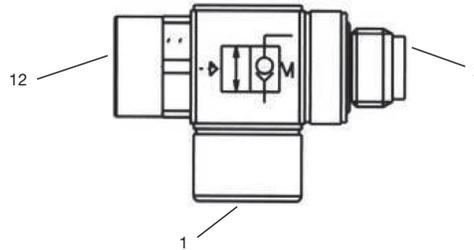

Minimum signal pressure  $p_{12}$  to open the valve

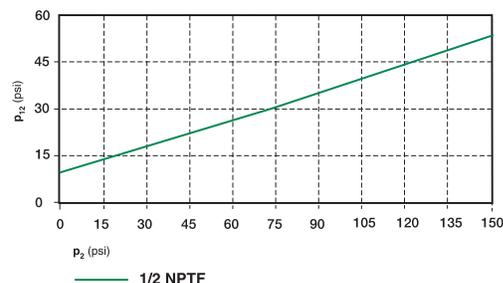
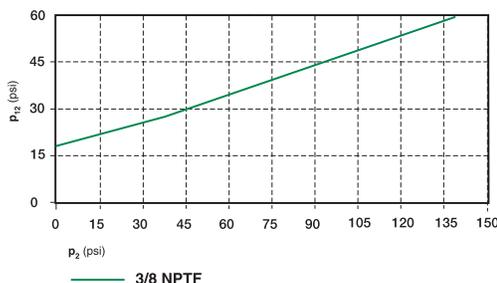
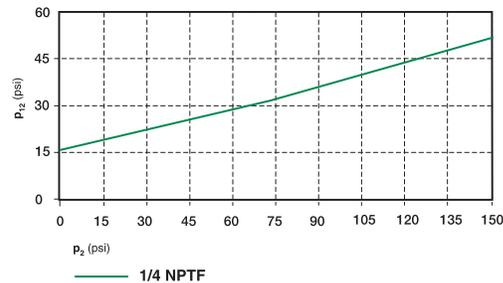
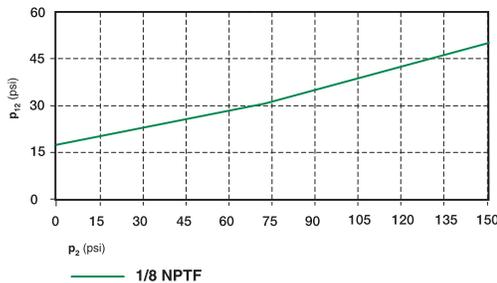

#### Dimensions: inches

### Dimensional Drawings - SEV Quick Exhaust Valve

#### Specifications

Quick exhaust valve, line mounting  
 Temperature Range: -40° °F to 165 °F  
 Pressure Range: 3.9 psi to 145 psi

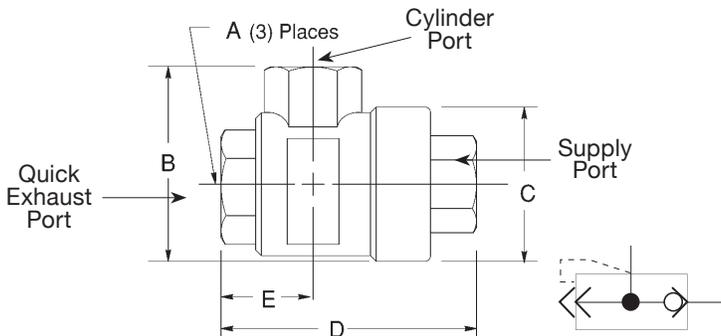

Ports NPTF	SEV_BN	A	B	C	D	E
1/8	SEV10BN	1/8	1.30	1.10	1.65	0.55
1/4	SEV25BN	1/4	1.58	1.30	2.05	0.71
3/8	SEV38BN	3/8	1.70	1.30	2.16	0.75
1/2	SEV50BN	1/2	2.17	1.69	2.80	1.06
3/4	SEV75BN	3/4	2.45	1.93	3.55	1.42

Ports G Tap	SEV_B	A	B	C	D	E
1/8	SEV10B	G1/8	33	28	42	14
1/4	SEV25B	G1/4	40	33	52	18
1/2	SEV50B	G1/2	55	43	71	27
3/4	SEV75B	G3/4	74	64	90	42
1	SEV100B	G1	88	80	108	48

NOTE: Service parts are available, please consult the factory.

### IN530 Slide Valve

#### Features

The IN530 Slide Valve allows easy isolation of downstream components by dumping circuit pressure.

#### Specifications

Temperature Range: 0 °F to 160 °F  
 Maximum Operating Pressure: 150 PSIG (10 bar)  
 Pipe Sizes: 1/8, 1/4, 3/8 1/2 NPTF

#### Materials of Construction

Sleeve: Aluminum  
 Body: Chrome-plated Brass  
 Seal: Buna-N  
 Snap Ring: Steel

F NPTF	IN530	D	L	SW
1/8	IN530-020-020	0.98	1.89	0.55
1/4	IN530-021-021	1.18	2.28	0.75
3/8	IN530-022-022	1.38	2.76	0.87
1/2	IN530-023-023	1.57	3.15	1.06

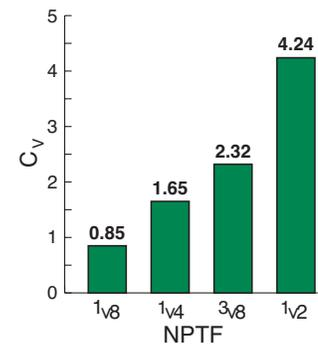
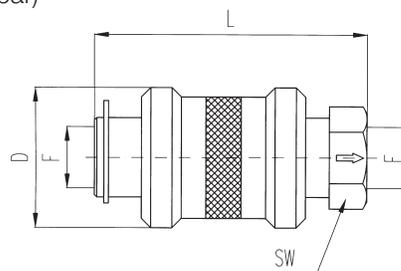

### OA22-1 Shuttle Valve

#### Specifications

Temperature Range: -4 °F to 194 °F  
 Pressure Range: 3.9 psi to 145 psi

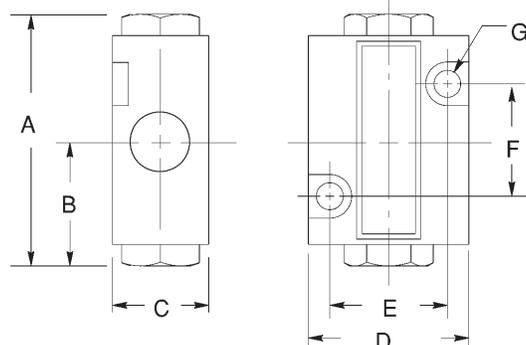

Ports NPTF	OA22-1	A	B	C	D	E	F	G
1/8	OA22-1	1.93	0.95	0.75	1.26	0.91	0.87	0.20

Dimensions: inches (mm)

Dimensional Drawings - M Series Metal Air Silencers

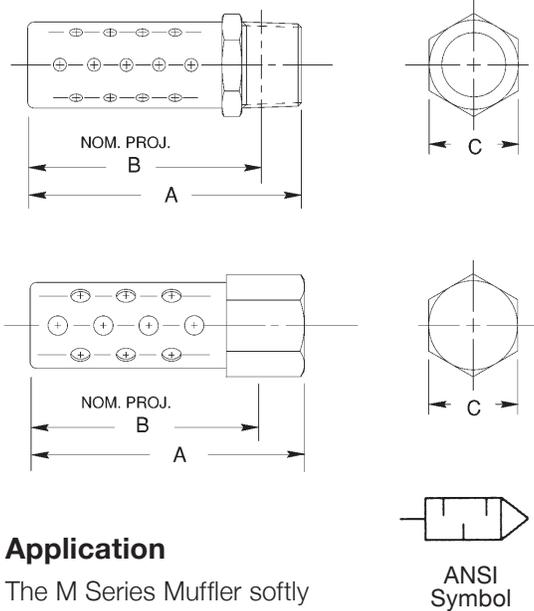

Application

The M Series Muffler softly exhausts air and disperses it over a 360° pattern. Constructed of a corrosion resistant metal, it can withstand shock and continuous, heavy-duty use under many conditions. This muffler is ideal for use on the 22/32 Series Solenoid Soft Start Quick Exhaust Valve, Lockout Valves, Valve Exhaust Ports, Single Acting Cylinders, and many other applications.

NPTF Male Dimensions

Model	NPTF	Cv	A	B	C
M1MN	1/8	1.17	1.38 (34.9)	1.22 (31.0)	0.44 (11.1)
M2MN	1/4	2.54	1.75 (44.5)	1.53 (38.9)	0.56 (14.3)
M3MN	3/8	5.08	2.25 (57.2)	2.00 (50.8)	0.69 (17.5)
M4MN	1/2	7.32	2.72 (69.1)	2.41 (61.1)	0.88 (22.2)
M5MN	3/4	13.87	3.16 (80.2)	2.81 (71.4)	1.06 (27.0)
M6MN	1	19.53	3.88 (98.4)	3.47 (88.1)	1.31 (33.3)
M7MN	1-1/4	28.32	4.50 (114.3)	4.16 (105.6)	1.69 (42.9)
M8MN	1-1/2	38.09	5.00 (127.0)	4.59 (116.7)	2.00 (50.8)
M9MN	2	52.73	5.50 (139.7)	5.06 (128.6)	2.38 (60.3)

NPTF Female Dimensions

Model	NPTF	Cv	A	B	C
M1FN	1/8	1.17	1.38 (34.9)	1.22 (31.0)	0.50 (12.7)
M2FN	1/4	2.54	1.75 (44.5)	1.53 (38.9)	0.62 (15.9)
M3FN	3/8	5.08	2.25 (57.2)	2.00 (50.8)	0.75 (19.1)
M4FN	1/2	7.32	2.72 (69.1)	2.41 (61.1)	0.94 (23.8)

BSPT Male Dimensions

Model	BSPT	Cv	A	B	C
M1MB	1/8	1.17	1.38 (34.9)	1.22 (31.0)	0.44 (11.1)
M2MB	1/4	2.54	1.75 (44.5)	1.53 (38.9)	0.56 (14.3)
M3MB	3/8	5.08	2.25 (57.2)	2.00 (50.8)	0.69 (17.5)
M4MB	1/2	7.32	2.72 (69.1)	2.41 (61.1)	0.88 (22.2)
M5MB	3/4	13.87	3.16 (80.2)	2.81 (71.4)	1.06 (27.0)
M6MB	1	19.53	3.88 (98.4)	3.47 (88.1)	1.31 (33.3)

SSM Series Stainless Steel Air Silencers

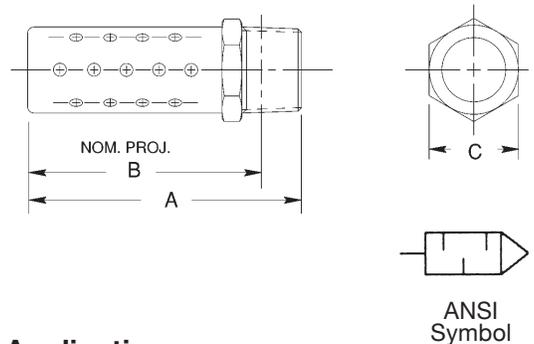

Application

The SSM Series Muffler is constructed with 300 Series stainless steel. Resistance to atmospheric corrosion, sterilizing solutions, organic chemicals, and many inorganic chemicals makes this a terrific product for dairy and food plants. The SSM Series Muffler softly exhausts air and disperses it over a 360° pattern. Because of its heavy-duty construction, it can withstand shock and continuous cycling.

NPTF Male Dimensions

Model	NPTF	Cv	A	B	C
SSM1MN	1/8	1.17	1.38 (34.9)	1.22 (31.0)	0.44 (11.1)
SSM2MN	1/4	2.54	1.75 (44.5)	1.53 (38.9)	0.56 (14.3)
SSM3MN	3/8	5.08	2.25 (57.2)	2.00 (50.8)	0.69 (17.5)
SSM4MN	1/2	7.32	2.72 (69.1)	2.41 (61.1)	0.88 (22.2)
SSM5MN	3/4	13.87	3.16 (80.2)	2.81 (71.4)	1.06 (27.0)
SSM6MN	1	19.53	3.88 (98.4)	3.47 (88.1)	1.31 (33.3)

### Dimensions: inches (mm)

### Dimensional Drawings - P Series Porous Bronze Air Silencers

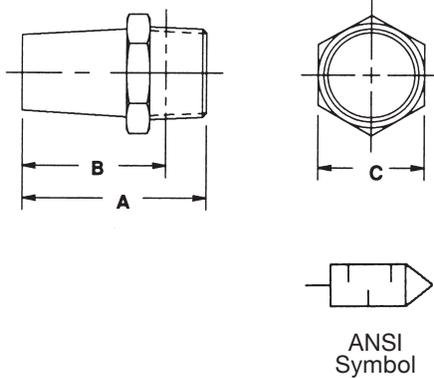

#### Application

The P Series Muffler is perfect for limited space applications due to its compact size. This silencer can be used to muffle air valve exhaust noise, intake filtration, coalescing of oil mist exhaust, pressure or vacuum equalization, or on any other liquid vapor.

#### NPTF Male Dimensions

Model	NPTF	Cv	A	B	C
P0MN	10-32	0.23	0.75 (19.1)	0.62 (15.7)	0.38 (9.5)
P1MN	1/8	1.07	0.84 (21.4)	0.69 (17.5)	0.44 (11.1)
P2MN	1/4	1.78	1.20 (30.6)	0.97 (24.6)	0.56 (14.3)
P3MN	3/8	2.30	1.45 (36.7)	1.20 (30.6)	0.69 (17.5)
P4MN	1/2	5.66	1.89 (48.0)	1.58 (40.1)	0.88 (22.2)
P5MN	3/4	9.67	2.12 (54.0)	1.78 (45.2)	1.06 (27.0)
P6MN	1	14.06	2.84 (72.2)	2.44 (61.9)	1.31 (33.3)
P7MN	1-1/4	20.51	3.44 (87.3)	3.00 (76.2)	1.69 (42.9)
P8MN	1-1/2	29.10	4.00 (101.6)	3.56 (90.5)	2.00 (50.8)
P9MN	2	44.92	4.75 (120.7)	4.31 (109.5)	2.38 (60.3)

#### BSPT Male Dimensions

Model	BSPT	Cv	A	B	C
P1MB	1/8	1.07	0.84 (21.3)	0.69 (17.5)	0.44 (11.1)
P2MB	1/4	1.78	1.20 (30.5)	0.97 (24.6)	0.56 (14.3)
P3MB	3/8	2.30	1.45 (36.8)	1.20 (30.5)	0.69 (17.5)
P4MB	1/2	5.66	1.89 (48.0)	1.58 (40.1)	0.88 (22.2)
P5MB	3/4	9.67	2.12 (53.9)	1.78 (45.2)	1.06 (27.0)
P6MB	1	14.06	2.84 (72.1)	2.44 (62.0)	1.31 (33.3)

### E Series Polyethylene Air Silencers

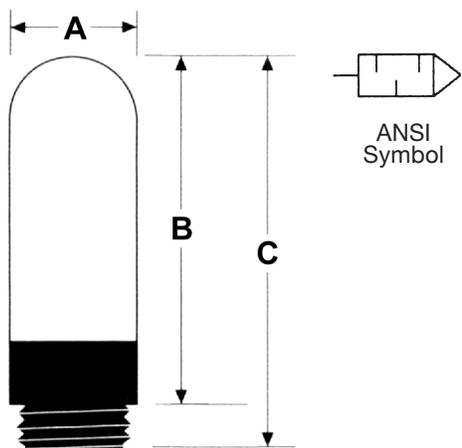

#### Application

Combining a sturdy nylon thread with a polyethylene body, the E Series Silencer gives a low-cost, lightweight alternative to heavier, metal-based mufflers while reducing decibel levels to an OSHA-approved level. It is perfect for robotic arm applications, low-traffic or enclosed areas, or where cost is of primary concern.

#### NPTF Male Dimensions

Model	NPTF	A	B	C
E1MN	1/8	0.49 (12.5)	1.1 (28.3)	1.3 (34.0)
E2MN	1/4	0.61 (15.5)	1.4 (35.5)	1.7 (42.5)
E3MN	3/8	0.73 (18.5)	2.2 (56.0)	2.7 (67.5)
E4MN	1/2	0.93 (23.5)	2.6 (67.0)	3.1 (78.0)
E5MN	3/4	1.50 (38.5)	4.9 (123.5)	5.5 (140.0)
E6MN	1	1.90 (49.0)	5.5 (140.5)	6.3 (160.0)

Dimensions: inches (mm)

Dimensional Drawings - Bronze Speed Control Muffler

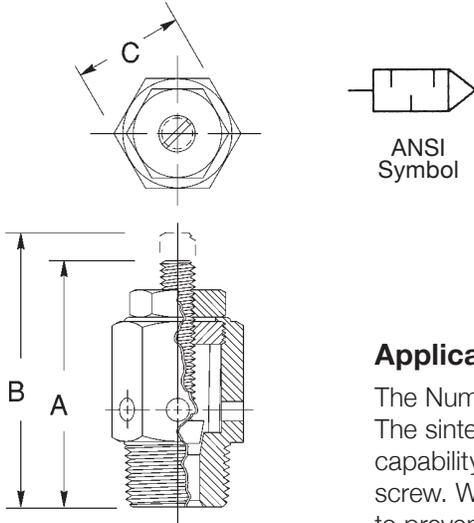

Model Selection

Port Size	Models NPT	Cv	A	B	C
1/8	A1MN	0.35	1.12 (28.4)	1.31 (33.3)	0.50 (12.7)
1/4	A2MN	0.67	1.42 (36.1)	1.56 (39.6)	0.63 (16.0)
3/8	A3MN	0.90	1.47 (37.3)	1.63 (41.4)	0.69 (17.5)
1/2	A4MN	1.35	1.75 (44.5)	2.00 (50.8)	0.88 (22.4)
3/4	A5MN	1.67	2.00 (50.8)	2.38 (60.5)	1.06 (27.0)
1	A6MN	2.32	2.25 (57.2)	2.50 (63.5)	1.31 (33.3)

Application

The Numatics Bronze Speed Control Muffler provides infinite metering of air flow. The sintered bronze is encased by an outer metal shroud. With linear adjusting capability, the speed of the cylinder can be decreased by adjusting the integrated screw. When optimal exhaust rate is reached, the locknut may be adjusted to prevent accidental adjustments due to vibration or other means. Maximum Operating Pressure: 300 psi; Temperature Range: 35 °F to 300 °F (1.7 °C to 149 °C).

Polyethylene Speed Control Muffler

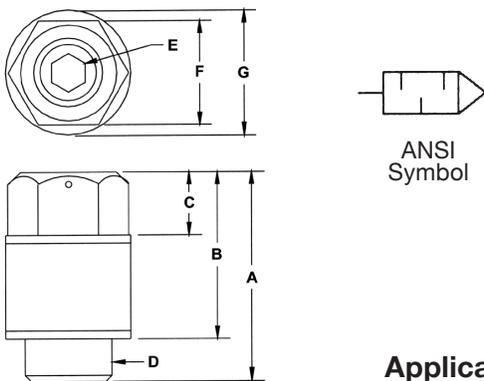

Model Selection

Port Size	Models NPT	A	B	C	D	E	F	G
M5	S0MN	0.52 (13.2)	0.36 (9.1)	0.36 (9.1)	M5	0.05 (1.3)	3.10 (78.7)	0.30 (7.6)
1/8	S1MN	0.69 (17.5)	0.49 (12.4)	0.16 (4.1)	1/8 NPT	0.08 (2.0)	5.10 (129.5)	0.49 (12.4)
1/4	S2MN	0.95 (24.1)	0.72 (18.3)	0.23 (5.8)	1/4 NPT	0.13 (3.3)	5.90 (150.0)	0.59 (15.0)
3/8	S3MN	1.20 (30.5)	0.98 (24.9)	0.36 (9.1)	3/8 NPT	0.20 (5.1)	7.90 (200.7)	0.79 (20.1)
1/2	S4MN	1.60 (40.6)	1.30 (33.0)	0.49 (12.4)	1/2 NPT	0.26 (6.6)	8.40 (213.4)	0.98 (24.9)

Application

The Polyethylene Speed Control Muffler is designed to give fine adjustment to the low end of the flow range, followed by more coarse control as flow is increased toward the maximum. The body is made of highly versatile and cost-effective nylon. The adjusting screw is made of high tensile steel and is coated with electroplated zinc. The S Series Muffler reduces decibel levels to an OSHA-approved level.

Dimensions: inches (mm)

### Dimensional Drawings - Breather Vent Silencer

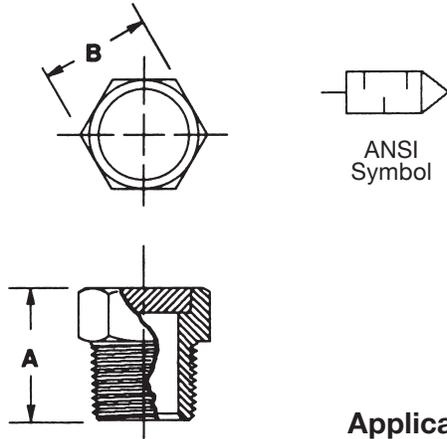

### Model Selection

Port Size	Models		Cv	A	B
	NPT	BSPT			
1/8	B1MN	B1MB	0.44	0.44 (11.2)	0.44 (11.2)
1/4	B2MN	B2MB	0.65	0.63 (16.0)	0.56 (14.2)
3/8	B3MN	B3MB	1.12	0.75 (19.1)	0.68 (17.3)
1/2	B4MN	B4MB	1.77	0.88 (22.4)	0.88 (22.4)
3/4	B5MN	B5MB	4.72	1.00 (25.4)	1.06 (27.0)
1	B6MN	B6MB	7.30	1.31 (33.3)	1.31 (33.3)
1-1/4	B7MN	B7MB	10.63	1.41 (35.8)	1.68 (42.7)
1-1/2	B8MN	B8MB	12.72	1.50 (38.1)	2.00 (50.8)

### Application

The Breather Vent Silencer offers some noise reduction, but is better suited for keeping contaminant out of valve exhaust ports, single-acting cylinder ports, or any other threaded port open to atmosphere which needs flow relief. It is also used on gear boxes, storage tanks, or wherever pressure equalization is needed. The Breather Vent Silencer is compact and inexpensive. Maximum Operating Pressure: 150 psi; Temperature Range: 35 °F to 300 °F (1.7 °C to 149 °C).

### C Series Inlet Filter Strainer

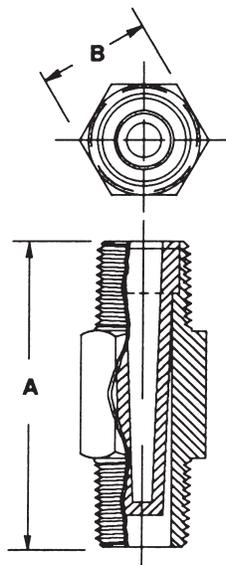

### Model Selection

Port Size	Models NPT	Cv	A	B
1/8	C1MN	0.31	1.25 (31.8)	0.43 (10.9)
1/4	C2MN	0.78	1.50 (38.1)	0.56 (14.2)
3/8	C3MN	1.0	1.75 (44.5)	0.69 (17.5)
1/2	C4MN	2.0	2.00 (50.8)	0.88 (22.4)

### Application

Ideal for air, oil, or water, the C Series Inlet Filter Strainer is compact and lightweight—perfect for point-of-use application. It features a brass fitting which contains a cone-shaped, sintered bronze, 40 micron filter. It is used as a prefilter, which eliminates bulk contamination from air lines, extending the life of filter elements and other downstream components.

Dimensions: inches

Dimensional Drawings - CV Series Check Valves

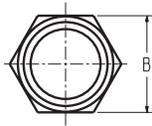
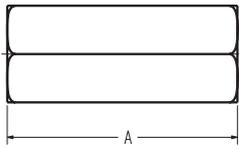

ANSI Symbol

Specifications

Operating Temperature:  
0 °F to 140 °F  
(5 °C to 60 °C)

Operating Pressure:  
3.5 PSIG to 213 PSIG  
(0.24 bar to 14.69 bar)

Materials of Construction

Body: Nickel-plated Brass  
Valve: Brass

Model Selection

Port Size	Models NPT	A	B
1/8	CV1FN-A	1.57	9/16
1/4	CV2FN-A	1.97	11/16
3/8	CV3FN-A	2.28	3/4
1/2	CV4FN-A	2.6	1

Application

Numatics CV Series Check Valves are used in fluid systems to permit free flow of air in one direction and prevent the flow in the opposite direction. Each check valve is clearly marked with a direction arrow to prevent accidental misconnection.



### Dimensions: inches

### Dimensional Drawings - QR300071 Tube Cutter

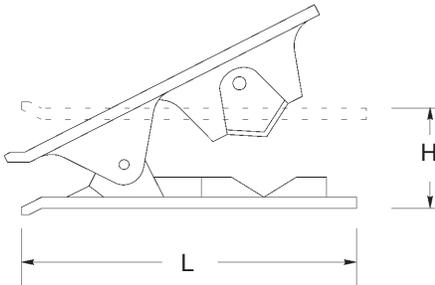

Model Number	Height (H)	Length (L)
QR3000 71 00	0.98	3.11

### Application

This tool will cut all composite tubes (e.g. nylon, PTFE, polyurethane, braided polyethylene, soft rubber, etc.) from 1/8" to 1/2" diameter inclusive. It is designed to give a clean cut at right angles to tube axis. A spring maintains the cutter in the closed position.

### How to Order

#### Tubing

	<b>QR</b>	<b>T</b>	<b>N</b>	<b>12</b>	<b>GN</b>	<b>1000</b>	
<b>Tubing</b>	_____			_____			
<b>Tubing Diameter</b>	_____			_____			
T = Inch							<b>Length (in feet)</b>
M = Metric							100
							250
							500
							1000
<b>Material</b>	_____			_____			<b>Color</b>
E = Low Density Polyethylene							CL = Clear
U = Polyurethane							BK = Black
N = Nylon							RD = Red
W = Weld Spatter Resistant							GN = Green
							BU = Blue
							YW = Yellow
				_____			<b>Tube Size</b>
							<b>Inch</b>
							12 = 1/8"
							16 = 5/32"
							19 = 3/16"
							25 = 1/4"
							31 = 5/16"
							38 = 3/8"
							50 = 1/2"
							<b>Metric</b>
							04 = 4mm
							06 = 6mm
							08 = 8mm
							10 = 10mm
							12 = 12mm

## ACCESSORIES

### Polyurethane 95 Tubing

#### Application

Polyurethane tubing is ideal for compressed air and vacuum systems. This rigid wall tubing is compatible with push-to-connect pneumatic fittings.

#### Features

Has excellent abrasion resistance and shape retention while working in high humidity and low temperatures. Withstands salt water, ages well, has good vibration absorption, and excellent tear resistance.

#### Specifications

- Vacuum Rating: to 28 inHg
- Temperature Range: -40 °F to 165 °F
- UV Stabilized
- Shore 95 A
- NSF61 Compliant
- Meets UL94HB
- Dimensional Tolerance
  - Imperial  $\pm 0.005$ in
  - Metric  $\pm 0.127$ mm

#### Inch

Model Number	O.D. (in)	I.D. (in)	Wall (in)	Min. Bend Radius (in)	Working Pressure (PSIG)				Weight (lbs/100ft)
					@ 75 °F	@ 100 °F	@125 °F	@ 150 °F	
QRTU12__	1/8	0.066	0.030	1/4	233	172	140	117	0.5
QRTU16__	5/32	0.093	0.031	3/8	176	130	106	88	0.7
QRTU19__	3/16	0.107	0.040	3/8	150	111	90	75	1.0
QRTU25__	1/4	0.160	0.045	1/2	148	110	89	74	1.5
QRTU31__	5/16	0.216	0.048	3/4	133	98	80	67	3.9
QRTU38__	3/8	0.245	0.065	7/8	147	109	88	74	3.4
QRTU50__	1/2	0.375	0.090	1-1/8	140	104	84	70	5.1

#### Metric

Model Number	O.D. (mm)	I.D. (mm)	Wall (mm)	Min. Bend Radius (mm)	Working Pressure (PSIG)				Weight (lbs/100ft)
					@ 75 °F	@ 100 °F	@125 °F	@ 150 °F	
QRMU04__	4	2.4	0.8	9.5	176	130	106	88	0.7
QRMU06__	6	4.0	1.0	12.7	145	107	87	73	1.3
QRMU08__	8	5.0	1.5	19.1	155	115	93	78	2.6
QRMU10__	10	6.5	1.75	22.2	149	110	89	75	3.9
QRMU12__	12	8.0	2.0	28.6	133	98	80	67	5.3

### Polyurethane Tubing for Numatrol® Series

#### Application

This highly flexible tubing allows easy connection to “barbed” fittings with sharp bends possible in less than one inch. Many Numatrol® installations that previously required the use of nylon tubing for high pressure, clamp functions for example, can now be easily accomplished with this tubing.

#### Features

Numatrol® polyurethane tubing offers superior performance to other composite tubing with regard to kink resistance. Low temperature flexibility, higher working pressures, and resistance to ambient ozone oil, grease, fuels and most chemicals.

#### Specifications

- Vacuum Rating: to 28 inHg
- Temperature Range: 0 °C to 200 °C
- Shore 83 A

Model Number	O.D. (in)	I.D. (in)	Tolerance			Working Pressure (PSIG)						Roll Length (ft)
			Wall (in)	O.D.	I.D.	@ 0 °C	@ 40 °C	@ 80 °C	@ 120 °C	@ 160 °C	@ 200 °C	
135-124	1/4	1/8	0.31	$\pm 0.008$	$\pm 0.005$	180	135	97	60	48	22	1000
135-125	1/4	1/8	0.31	$\pm 0.008$	$\pm 0.005$	180	135	97	60	48	22	100
135-127	1/8	1/16	0.15	$\pm 0.005$	$\pm 0.005$	180	135	97	60	48	22	1000
135-126	1/8	1/16	0.15	$\pm 0.005$	$\pm 0.005$	180	135	97	60	48	22	100

### Low Density Polyethylene Tubing

- Lightweight and flexible
- Superior dielectric properties
- Easily heat sealed
- Tasteless and odorless
- Impermeable to gases and moisture

LDPE is extruded to close tolerances from high quality, low density polyethylene resins. All colors except red comply with FDA regulation 21 CFR 177.1520(c) for food contact applications. LDPE has a water absorption rate of 0.15% per ASTM D-570 standards.

#### Inch

Model Number	O.D. (in)	I.D. (in)	Wall (in)	Min. Bend Radius (in)	Working Pressure (PSIG)	
					@ 75 °F	@ 150 °F
QRTE12	1/8	0.062	0.031	1/2	305	120
QRTE16	5/32	0.106	0.025	1	175	70
QRTE25	1/4	0.170	0.040	1-1/4	200	80
QRTE31	5/16	0.187	0.062	1-1/2	230	90
QRTE38	3/8	0.250	0.062	2	190	75
QRTE50	1/2	0.375	0.062	2-1/2	135	55

### Nylon 11 Tubing

#### Application

Flexible nylon tubing used for air and lubrication lines, instrumentation and process lines for chemicals and solvents. Contact factory for specific applications.

#### Features

Has excellent resistance to a wide range of chemicals including petroleum products, soaps, salt solutions, and bases.

#### Inch

Model Number	O.D. (in)	I.D. (in)	Wall (in)	Min. Bend Radius (in)	Working Pressure (PSIG)			
					@ 75 °F	@ 100 °F	@125 °F	@ 150 °F
QRTN12__	1/8	0.093	0.017	3/8	225	168	133	125
QRTN16__	5/32	0.106	0.025	1/2	275	200	169	160
QRTN19__	3/16	0.138	0.024	5/8	225	158	120	113
QRTN25__	1/4	0.180	0.035	1	250	183	160	140
QRTN31__	5/16	0.232	0.040	1-1/4	220	170	141	121
QRTN38__	3/8	0.275	0.050	1-1/2	220	165	148	128
QRTN50__	1/2	0.375	0.062	2	200	145	133	125

#### Metric

Model Number	O.D. (mm)	I.D. (mm)	Wall (mm)	Min. Bend Radius (mm)	Working Pressure (PSIG)			
					@ 75 °F	@ 100 °F	@125 °F	@ 150 °F
QRMN04__	4	2.7	0.6	12.7	350	263	228	210
QRMN06__	6	4	1	17	340	255	221	200
QRMN08__	8	6	1	38	250	187.5	162.5	150
QRMN10__	10	8	1	51	190	142.5	123.5	110
QRMN12__	12	10	1	76	150	112.5	97.5	90

### Specifications

- Temperature Range: All Diameters: -40 °F to 150 °F
- Vacuum Rating: to 28 inHg
- Diameter Tolerances: + 0.004"
- Hardness: LDPE: 44 Shore D
- Tube Markings: FW Specifications
- Working Pressure: 3:1 Safety Factor
- Base Resin Compliance: FDA (except red) NSF51 (LLDPE)
- Recommended Fittings: LDPE: Push-in, Compression

#### Metric

Model Number	O.D. (mm)	I.D. (mm)	Wall (mm)	Min. Bend Radius (mm)	Working Pressure (PSIG)	
					@ 75 °F	@ 150 °F
QRME04	4	2.7	.65	25.2	175	70
QRME06	6	4	1	31.8	175	70
QRME08	8	6	1	38	140	55
QRME10	10	8	1	51	115	45
QRME12	12	9	1.5	63.5	135	55

### Specifications

- Temperature Range: -60 °F to 200 °F
- Vacuum Rating: to 28 inHg
- Diameter Tolerances: + 0.002", - 0.004"  
Metric: + 0.051mm, - 0.1mm
- Hardness: 78 Rockwell R
- Working Pressure: 4:1 Safety Factor
- UV Stabilized: Yes
- Base Resin Compliance: Meets UL94HB Testing Requirements
- Recommended Fittings: Push-in, Compression

**Weld Spatter Resistant****Features**

- Protects tube from incidental weld spatter contact
- Flexible with an excellent bend radius
- Resistant to kink damage
- Broad range of chemical resistance
- Can be formed into retractable coils

**Specifications**

- Temperature Range: All Diameters: -40 °F to 165 °F
- Vacuum Rating: to 28 inHg
- Diameter Tolerances: +/- 0.005" Inner
- Working Pressure: 3:1 Safety Factor
- Base Resin Compliance:
  - Outer Jacket: Meets UL94VO Testing Requirements
  - Inner Tube: Meets UL94HB Testing Requirements
- Recommended Fittings: Push-in, Compression

**Metric**

Model Number*	O.D. (mm)	I.D. (mm)	Min. Bend Radius (mm)	Working Pressure (PSIG)		Weight (lbs/100ft)
				@ 25 °F	@ 65 °F	
QRMW06	6	4	12.7	160	65	2.59
QRMW08	8	5	19	190	75	4.15
QRMW10	10	6.5	22.2	170	70	5.71
QRMW12	12	8	28.6	155	60	7.43

#### Dimensions: inches (mm)

### Dimensional Drawings - EDV Series Electronic Drain Valves



EDV-04-110AC pictured

#### Application

Eliminate the manual draining of air lines with the EDV Series Electronic Drain Valve from Numatics. The EDV Series Valve is designed to remove condensation from filters, receiver tanks, separators, drip legs, drain traps, and dryers in electronically controlled intervals. The EDV valve is available in 1/4, 3/8, and 1/2 sizes. The large orifice allows even the largest rust and pipe scale particles to be easily expelled. Standard model includes a 110 Volt AC solenoid, 6ft (2m) power cord, and grounded plug. An EDV valve can be installed virtually anywhere.

#### Specifications

##### Valve

- Function: 2-Way, NC, Solenoid Valve
- Valve Design: Pilot Operated Diaphragm Valve
- Port Sizes: 1/4, 3/8
- Orifice: 5/16" (8mm) 1.12 Cv; 1/2" (12mm) 2.45 Cv
- Operating Pressure: 20 – 300 PSIG (1.3 – 20 bar)
- Solenoid: Continuous Duty
- Mounting: Any Position
- Body Material: Brass

##### Timer

- Material: Plastic Polyamid
- Interval Timer: 1 – 45 min.
- 'On' Timer: 0.25 – 25 sec.
- Voltage: 12 – 230 V AC/DC
- Frequency: 50/60 Hz
- Power Rating: 10 Watt
- Enclosure: NEMA 4/IP65
- Ambient Temp: 130 °F (55 °C)

##### Lights

- Left Indicator: Power On
- Right Indicator: Solenoid Engineered

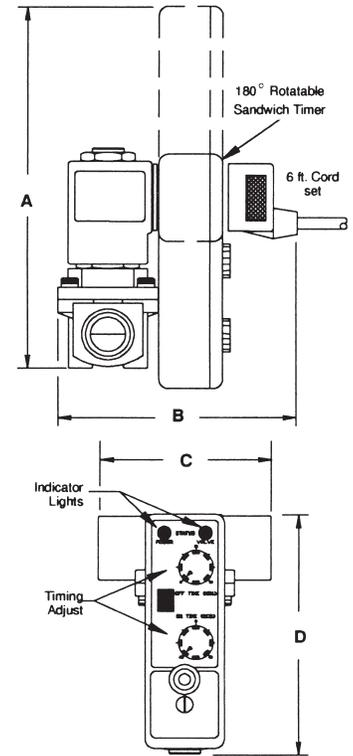

Series	A	B	C	D
1/4, 3/8	5.75 (146)	3.5 (89)	2.25 (57)	3.75 (95)
1/2	6.0 (152)	3.5 (89)	2.75 (70)	3.75 (95)

### How to Order

#### Electronic Drain Valves

**Model** \_\_\_\_\_ **EDV** - **04** - **110** **AC**

EDV = Electronic Drain Valve

**Threads** \_\_\_\_\_

- = NPT  
B = BSPT

**Port Size** \_\_\_\_\_

02 = 1/4  
03 = 3/8  
04 = 1/2

**Current**

AC  
DC

**Voltage**

12  
24  
110  
230

**Connector**

- = 6ft (2m) Power Cord (with Grounded Plug)  
X = Conduit Connector

Dimensions: inches (mm)

Dimensional Drawings - PS180 Pressure Switches

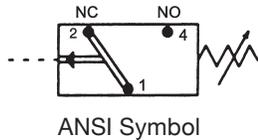

Application

Numatics PS180 is a line of pressure switches designed for accurate indication that proper system pressure is being achieved. Available in 1/8 or 1/4 threads, it is easily incorporated into an air system using a FlexiBlok® Diverter Plate.

Featuring a rugged housing made from zinc-coated steel, the PS180 is designed for industrial multi-million cycle life applications. The 4-pin connector plug is included and contains a key way of preventing accidental misconnection. Pressure adjustment is tamper resistant, hindering unauthorized changes. It can be wired in either normally open or normally closed configurations and includes a case ground pin.

Specifications

- Contact Rating: 4A @ 250 V AC
- Protection: IP 65, Terminals IP00
- Maximum Operation: 200/min
- Temperature Range: 0 °F to 190 °F (-15 °C to 85 °C)
- Maximum Pressure: 300 PSI (20 bar)
- Maximum Voltage: 250 V AC (200 DC)
- Hysteresis Adjustment: 15%
- Connector Material: Polyamid
- Diaphragm Material: Buna-N
- Housing Material: Zinc-plated Steel

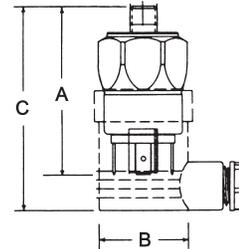

NPTF Thread Model Selection

NPTF	Model	PSIG (bar)
1/8	PS180BAN01	4 – 20 (0.3 – 1.5)
1/8	PS180CAN01	14 – 150 (1 – 10)
1/4	PS180BAN02	4 – 20 (0.3 – 1.5)
1/4	PS180CAN02	14 – 150 (1 – 10)

NPTF Thread Dimensions

Model	A	B	C
PS180BAN01	2.5 (64)	1.0 (27)	3.1 (79)
PS180CAN01	2.5 (64)	1.0 (27)	3.1 (79)
PS180BAN02	2.5 (64)	1.0 (27)	3.1 (79)
PS180CAN02	2.5 (64)	1.0 (27)	3.1 (79)

BSPB Thread Model Selection

BSPB	Model	PSIG (bar)
1/4	PS180CAG02	14 – 150 (1 – 10)
1/4	PS180CAG02	14 – 150 (1 – 10)

BSPB Thread Dimensions

Model	A	B	C
PS180BAG02	2.3 (58)	1.0 (27)	2.9 (74)
PS180CAG02	2.3 (58)	1.0 (27)	2.9 (74)

NOTE: Use G suffix for gold-plated terminals (for applications below 50 mA), ex: PS180BAN02G

PS182 Pressure Switches

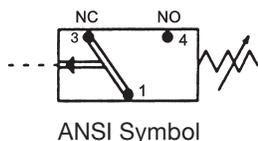

Application

Numatics PS182 is the most rugged of the Numatics Pressure Switches. Available in 1/8 or 1/4 NPT and BSPB threads, it is easily incorporated into an air system using a FlexiBlok® Diverter Plate or Diverter Block.

The unique 12mm Micro Connector makes it simple for electrical connection. The knurled knob with tamper resistant hex screw makes it the easiest pressure adjustment on the market. It can be wired in either a normally open or normally closed configuration.

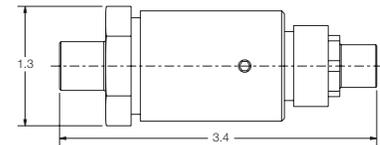

Specifications

- Hysteresis Adjustment: 10%
- Pressure Ranges: 2 – 10, 6 – 30, 20 – 130
- Maximum Pressure: 600 psi
- Set Point Tolerance: +/- 1 psi or 5%
- \*Contact Rating: 4A
- Diaphragm Material: Buna-N
- Maximum Operating Cycles: 200/min
- Temperature Range: -40 °F to 250 °F (-40 °C to 121 °C)
- Voltage Range: 12 V DC to 250 V AC
- Sealing/Protection: IP 65
- Housing Material: Brass
- Electrical Connection: 3-Pin Micro (12mm)

\*Comes standard with gold-plated contacts.

Female Single Ended Cordset

Connector Type	Connector Length	Model Number
90° Elbow	5 Meters	PS182-5-90
Straight	5 Meters	PS182-5-ST

NPTF Thread Model Selection

NPTF	Model	PSIG (bar)
1/8 NPT	PS182AAN01	2 – 10 (0.14 – 0.69)
1/8 NPT	PS182BAN01	6 – 30 (0.40 – 2.07)
1/8 NPT	PS182CAN01	20 – 130 (1.38 – 8.96)
1/4 NPT	PS182AAN02	2 – 10 (0.14 – 0.69)
1/4 NPT	PS182BAN02	6 – 30 (0.40 – 2.07)
1/4 NPT	PS182CAN02	20 – 130 (1.38 – 8.96)

BSPB Thread Model Selection

BSPB	Model	PSIG (bar)
1/8 BSPB	PS182AAG01	2 – 10 (0.14 – 0.69)
1/8 BSPB	PS182BAG01	6 – 30 (0.40 – 2.07)
1/8 BSPB	PS182CAG01	20 – 130 (1.38 – 8.96)
1/4 BSPB	PS182AAG02	2 – 10 (0.14 – 0.69)
1/4 BSPB	PS182BAG02	6 – 30 (0.40 – 2.07)
1/4 BSPB	PS182CAG02	20 – 130 (1.38 – 8.96)

### FlexiBlok® Coalescing Filter

#### Element Replacement Kits Filter & Filter-Reg

Includes filter element and seal

Kit #	Description
<b>12 &amp; 14 Series</b>	
EKF12C	0.7 micron Element
EKF12CD	0.7 micron Element with Prefilter
EKF12D	0.3 micron Element
EKF12DD	0.3 micron Element with Prefilter
EKF12E	0.01 micron Element
EKF12ED	0.01 micron Element with Prefilter
EKF12F	Adsorbing Element

#### 22 Series

EKF22C	0.7 micron Element
EKF22CD	0.7 micron Element with Prefilter
EKF22D	0.3 micron Element
EKF22DD	0.3 micron Element with Prefilter
EKF22E	0.01 micron Element
EKF22ED	0.01 micron Element with Prefilter
EKF22F	Adsorbing Element

#### 32 Series

EKF32C	0.7 micron Element
EKF32CD	0.7 micron Element with Prefilter
EKF32D	0.3 micron Element
EKF32DD	0.3 micron Element with Prefilter
EKF32E	0.01 micron Element
EKF32ED	0.01 micron Element with Prefilter
EKF32F	Adsorbing Element

#### 42 Series

EKF42C	0.7 micron Element
EKF42CD	0.7 micron Element with Prefilter
EKF42D	0.3 micron Element
EKF42DD	0.3 micron Element with Prefilter
EKF42E	0.01 micron Element
EKF42ED	0.01 micron Element with Prefilter
EKF42F	Adsorbing Element

#### DPI Replacement Kits

Includes DPI assembly

Kit #	Description
UK600	14 Series DPI Replacement Kit
DPI22	22 Series DPI Replacement Kit
DPI32	32/42 Series DPI Replacement Kit

#### Bowl Replacement Kits Filter & Filter-Reg

Includes bowl and O-ring

Kit #	Description
<b>12 &amp; 14 Series</b>	
BKF12	Polycarbonate Bowl with Guard
BKF12C	CircleVision™ Bowl
BKF12M	Metal Bowl

#### 22 Series

BKF22	Polycarbonate Bowl
BKF22C	CircleVision™ Bowl
BKF22M	Metal Bowl

#### 32 Series & 42 Series

BKF32	Polycarbonate Bowl
BKF32C	CircleVision™ Bowl
BKF32M	Metal Bowl

To order the Bowl Replacement Kit with a Drain, specify the drain suffix in the kit number (keeping suffixes in alphabetical order). For example, to order a Flexible Drain with a BKF12 kit, order as **BKF12B**. To order an External Pulse Drain with a BKF12M kit, order as **BKF12JM**. Drain suffixes are as follows: B = Flexible Drain, J = External Pulse Drain, Q = Metal Manual Drain, R = Manual Lever Drain. See page 35 for additional drain option information.

#### Bowl Replacement Kits Lubricator

Includes bowl and O-ring

Kit #	Description
BKL12	12 & 14 Series Polycarbonate Bowl
BKL12M	12 & 14 Series Metal Bowl
BKL22	22 Series Polycarbonate Bowl
BKL22C	22 Series CircleVision™ Bowl
BKL22M	22 Series Metal Bowl
BKL32	32 Series Polycarbonate Bowl
BKL32C	32 Series CircleVision™ Bowl
BKL32M	32 Series Metal Bowl

To order the Bowl Replacement Kit with a Drain or Buttonhead Fill, specify the appropriate suffix in the kit number (keeping suffixes in alphabetical order). For example, to order a Drain with a BKL12 kit, order as **BKF12K**. To order a Buttonhead Fill with a BKL22M kit, order as **BKL22FM**. Drain suffixes are as follows: F = Buttonhead Fill, K = Drain.

#### Replacement Drain Kit

Kit #	Description
AKF02	Auto Float Drain Kit (incl. drain, bushing, clip, O-ring)
BKF02	Flexible Drain (includes drain assembly)
DKF02	Standard Drain (incl. drain assembly)
QKF02	Metal Manual Drain (incl. drain, bushing, clip, O-ring)
JKF02	External Pulse Drain (incl. drain, bushing, clip, O-ring)
RKF02	Manual Lever Drain (incl. drain, bushing, clip, O-ring)

### FlexiBlok® Particulate Filter

#### Element Replacement Kits Filter & Filter-Reg

Includes bowl and O-ring

Kit #	Description
EKF12A	12 & 14 Series 40 micron Element
EKF12B	12 & 14 Series 5 micron Element
EKF22A	22 Series 40 micron Element
EKF22B	22 Series 5 micron Element
EKF32A	32 Series 40 micron Element
EKF32B	32 Series 5 micron Element
EKF42A	42 Series 40 micron Element
EKF42B	42 Series 5 micron Element

#### Filter Repair Kits

Includes Turbo-Flo, element retainer, quiet zone baffle, deflector retainer

Kit #	Description
RKF12B	12 & 14 Series 5 micron Element
RKF22B	22 Series 5 micron Element
RKF32B	32 Series 5 micron Element
RKF42B	42 Series 5 micron Element

### FlexiBlok® Regulator

#### Regulator & F/R Repair Cage Kits

Includes bonnet with main spring (0 - 125 psi), adjusting screw and adjusting knob

Kit #	Description
RKC14	14 Series
RKC22	22 Series
RKC32	32 Series
RKC42	42 Series

#### Diaphragm Repair Kits

Includes diaphragm, inner valve assembly and inner valve spring

Kit #	Description
RKR12R	12 & 14 Series Relieving Kit
RKR22R	22 Series Relieving Kit
RKR32R	32 Series Relieving Kit
RKR42R	42 Series Relieving Kit
RKR12N	12 & 14 Series Non-relieving Kit
RKR22N	22 Series Non-relieving Kit
RKR32N	32 Series Non-relieving Kit
RKR42N	42 Series Non-relieving Kit

#### Piston Repair Kits

Includes piston assembly, inner valve assembly and inner valve spring

Kit #	Description
RKR12R	12 & 14 Series Relieving Kit
PKR12R	12 Series Relieving Kit
PKR12N	12 Series Non-relieving Kit
PKR14R	14 Series Relieving Kit
PKR22R	22 Series Relieving Kit
PKR32R	32 Series Relieving Kit
PKR42R	42 Series Relieving Kit
PKR14N	14 Series Non-relieving Kit
PKR22N	22 Series Non-relieving Kit
PKR32N	32 Series Non-relieving Kit
PKR42N	42 Series Relieving Kit

#### Replacement Adjustment Knob Kits

Includes adjustment knob only

Kit #	Description
R12-03	12 & 14 Series Adjustment Knob
R22-03B	22 Series Adjustment Knob
R32-03	32 Series Adjustment Knob
R32-03	42 Series Adjustment Knob

### FlexiBlok® Pilot Operated Regulator

#### Diaphragm Repair Kits

Includes upper & lower diaphragm, inner valve assembly and inner valve spring

Kit #	Description
RKW22	22 Series Relieving Kit
RKW32	32 Series Relieving Kit
RKW42	42 Series Relieving Kit
RKW22N	22 Series Non-relieving Kit
RKW32N	32 Series Non-relieving Kit
RKW42N	42 Series Non-relieving Kit

### FlexiBlok® Lubricator

#### Lubricator Dome Repair Kits

Includes adjustment knob and adjustment assembly

Kit #	Description
RKL12T	12 & 14 Series Lubricator Dome Repair Kit
	22 Series Lubricator Dome Repair Kit
	32 Series Lubricator Dome Repair Kit
	42 Series Lubricator Dome Repair Kit

#### Replacement Adjustment Knob Kits

Includes adjustment knob only

Kit #	Description
L32-06	12 & 14 Series Adjustment Knob
	22 Series Adjustment Knob
	32 Series Adjustment Knob

### FlexiBlok® Shut Off Valve

#### Shut Off Valve Repair Kits

Includes slide and 2 O-rings

Kit #	Description
RKSV12	12 Series Shut Off Valve Repair Kit
RKSV14	14 Series Shut Off Valve Repair Kit
RKSV22	22 Series Shut Off Valve Repair Kit
RKSV32	32 Series Shut Off Valve Repair Kit

#### Mounting Brackets

Includes bracket and panel nut

Kit #	Description
PK12	12 & 14 Series Mounting Bracket
PK22	22 Series Mounting Bracket
PK32	32 Series Mounting Bracket

### FlexiBlok® Solenoid Soft Start Quick Exhaust

#### Solenoid Replacement Kits

Includes coil only (fits 22 or 32 Series)

Kit #	Description
S32-44A	110 V (fits 22 or 32 Series)
S32-45A	230 V (fits 22 or 32 Series)
S32-46A	24 V AC (fits 22 or 32 Series)
S32-43A	24 V DC (fits 22 or 32 Series)

NOTE: Numatics FRL does not recommend the disassembly of a Solenoid Soft Start unit outside of our factory.

### FlexiBlok® Screws & O-rings

#### Screw and O-ring Replacement Kits

Includes piston assembly, inner valve assembly and inner valve spring

Kit #	Description
KAVS12-06	12 Series incl. 2 81mm tie rods, 2 106mm tie rods, 4 nuts
BKAVS12-0	12 Series incl. 20 81mm tie rods, 20 106mm tie rods, 40 nuts
KG12	12 Series incl. 2 screws, 1 O-ring (M4 x 12mm)
KGB12	12 Series bulk pack 100 screws, 50 O-rings (M4 x 12mm)
KG14	14 Series incl. 2 screws, 1 O-ring (M4 x 12mm)
KGB14	14 Series bulk pack 100 screws, 50 O-rings (M4 x 12mm)
KG22	22 Series incl. 2 screws, 1 O-ring (M5 x 12mm)
KGB22	22 Series bulk pack 100 screws, 50 O-rings (M5 x 12mm)
KG32	32 Series incl. 2 screws, 1 O-ring (M6 x 16mm)
KGB32	32 Series bulk pack 100 screws, 50 O-rings (M6 x 16mm)
KG42	42 Series incl. 2 screws, 1 O-ring (M8 x 1.25mm)
KGB42	42 Series bulk pack 100 screws, 50 O-rings (M8 x 1.25mm)

NOTE: Numatics FRL does not recommend the disassembly of a Solenoid Soft Start unit outside of our factory.













## Global Contacts

Australia	(61) 2-9-451-7077	France	(33) 2-37-24-42-24	Netherlands	(31) 33-277-7911
Brazil	(55) 11-4208-1700	Germany	(49) 7237-9960	Singapore	(65) 6556-1100
Canada	(1) 519-758-2700	India	(91) 44-39197300	South Korea	(82) 2-3483-1570
China	(86) 21-3395-0000	Italy	(39) 02-356931	Spain	(34) 942-87-6100
Czech Republic	(420) 235-090-061	Japan	(81) 798-65-6361	United Kingdom	(44) 1695-713600
Dubai - UAE	(971) 4-811-8200	Mexico	(52) 55-5809-5640		