

# numatics®

## 450 & 453 Series

Standard Cylinder to ISO 15552

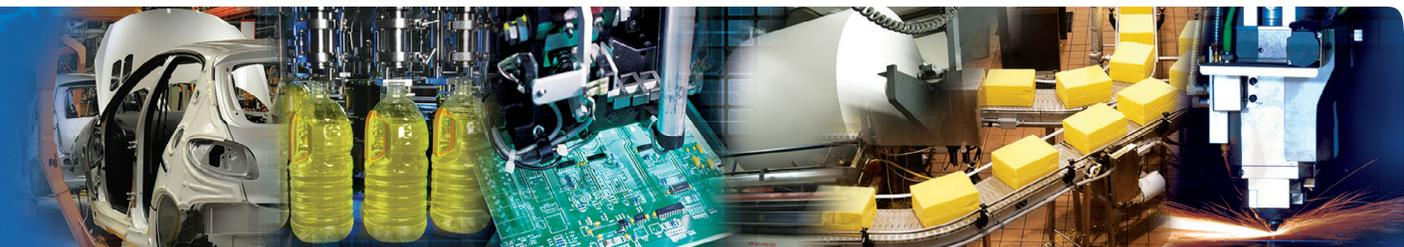

# NUMATICS®

**Numatics, Inc. is a leading manufacturer of pneumatic products and motion control products.** Our broad spectrum of standard, custom developed products and application components, have made a significant impact on pneumatic innovation as well as pneumatic and motion control technology. Our company has an extensive history of generating innovative concepts and technological breakthroughs. Many of today's standard features in pneumatic technology were industry firsts from Numatics. We continue our innovative approach to product development by developing electric motion control solutions and enhancing our embedded Fieldbus and I/O products to continually meet and solve our customer's application requirements.



**Today Numatics is proud to be a part of Emerson Electric Co.**

Emerson (NYSE:EMR), based in St. Louis, Missouri (USA), is a global leader in bringing technology and engineering together to provide innovative solutions for customers in industrial, commercial, and consumer markets through its network power, process management, industrial automation, climate technologies, and appliance and tools businesses. For more information, visit [www.Emerson.com](http://www.Emerson.com).





Numatics Express Shipping Program guarantees<sup>†</sup> product shipment in two, three or five business days. Unlike most

traditional quick ship programs, the Numatics Express Shipping Program includes the most comprehensive offering in the industry. This program encompasses the range and options that you require!

Numatics is committed to offering you the highest level of customer service, quality and performance.

## 2DAY

Numatics Express 2Day shipping program guarantees<sup>†</sup> product shipment in two business days. The program includes the most popular valve, air preparation and actuator products and includes applicable switches and mounting accessories.

Numatics guarantees<sup>†</sup> to ship any order received before 3 pm EST for up to 10 2Day products\* in two business days.

## 3DAY

Numatics Express shipping program offers a 3Day shipping program that guarantees<sup>†</sup> product shipment of a fully assembled and tested valve manifold in 3 business days. The program includes the most popular manifold configurations of the 2000 and Mark series valves:

- Sub D, Terminal Strip and Fieldbus Electronic Options
- Can be configured for DIN Rail Mounting and Muffled Exhaust
- Shipped complete and 100% tested

The 3Day Express shipping program enables you to create a 2 to 8 station manifold assembly complete with any combination of valves, regulators, and blank stations that can be configured from the valve model charts in this catalog.

Numatics guarantees<sup>†</sup> to ship any order received before 3 pm EST for up to 5 manifold assemblies configured from this catalog in three business days or Numatics pays the shipping cost.

## 5DAY

We are pleased to expand Numatics Express to include a broad range of products in a 5Day shipping program. Numatics guarantees<sup>†</sup> to ship up to 10 of any 5Day product\*\* for orders received before 3 pm EST in 5 business days or Numatics pays the shipping cost.

We are committed to providing you with an unmatched level of customer service, quality, and reliability.

If you cannot locate the specific product for your application or need additional product specifications, visit [www.numatics.com](http://www.numatics.com) or call **888-686-2842**. Numatics Express orders cannot be canceled or adjusted once entered. Saturdays, Sundays, and Holidays are excluded.

<sup>†</sup>As industry requirements change, Numatics reserves the right to modify the contents of this catalog and program without notification. Updates on this program can be obtained from the Numatics website [www.numatics.com](http://www.numatics.com) or by calling 888-686-2842, or by contacting your local Numatics representative or distributor and referencing the Numatics Express program.

**\*Sentronic<sup>®</sup> Proportional Valves, CGT Compact Slides, NR Series Rodless and Air Bellows are limited to orders up to 5.**

**\*\*A Series Large Bore NFPA, ASP Series Steel Body NFPA and G Series Guide Rail Rodless are limited to orders up to 5.**

# Welcome to the World of Fluid Automation...

Since 1945, Numatics has emerged as the prominent specialist in developing and manufacturing pneumatic and fluid power components for a widely diverse field of automated industry. From idea to implementation, leading engineers choose Numatics as their single source for:

- Quality Fluid Power components
- Technologically advanced design resources
- Quick response time in delivery and service from around the world

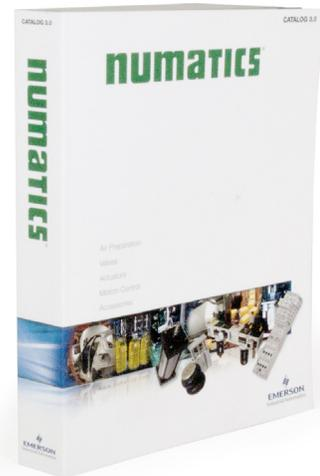

## Numasizing®

Developed by Numatics, Numasizing® offers a whole new level of fluid power system optimization. Compare large amounts of component and process data against user objectives and industry benchmarks for the best possible size, pneumatic pressure, actuator stroke velocities and other part and process variable determinations.

## CAD Modeling

Save critical development time with the most innovative CAD configuration program in the pneumatic component industry. Numatics in 3D eliminates the time consuming process associated with designing components from scratch based on information found in conventional paper catalogs.

The models are available in 85 different native CAD formats in 2D drawings and 3D models, including all the popular formats including Catia, I-DEAS, Pro/Engineer, SolidWorks, Unigraphics and more.

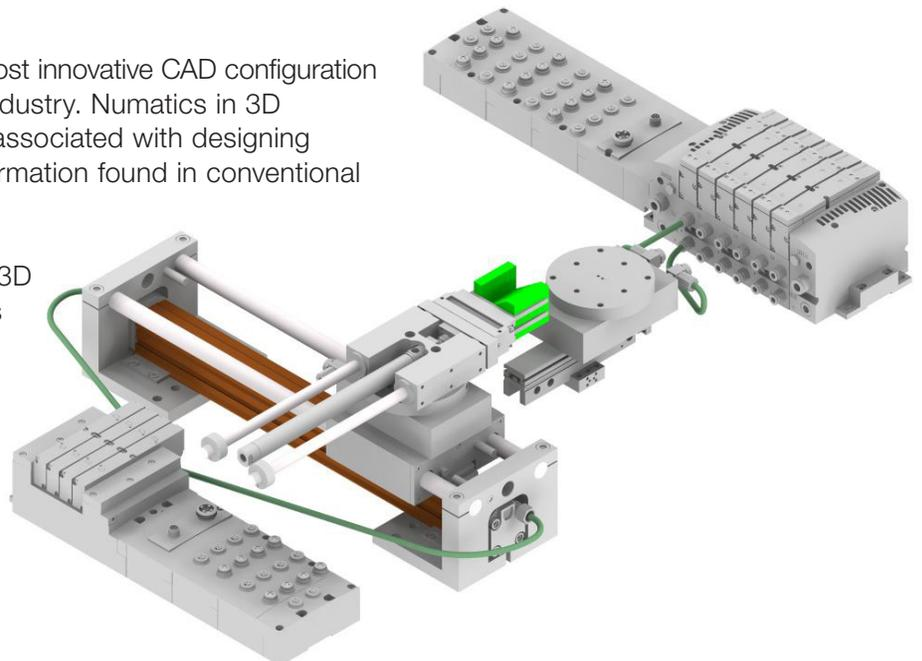

## 450 Series

Features and Benefits	2
Cylinder How to Order	3
Single and Double Rod	4

## 453 Series

Features and Benefits	5
Cylinder How to Order	6
Single and Double Rod	7

## 453 Series Slide

Slide Features and Benefits	8
Cylinder How to Order	9
Slide Load Information	10-11

## NRL Series

Features and Benefits	12
Product Information	13-18
Rod Lock How to Order	16

## Mountings

Cylinder Standard Mount Information	19-25
-------------------------------------	-------

## Sensor Information

"T-Slot" Position Detectors Reed Switch and Hall Effect Sensor	26-28
--	-------

### 450 Series

The 450 Series is an aluminum body with stainless steel tie rod air cylinder line that is designed to meet all ISO 15552 requirements. The 450 Series offers an extensive range of accessories allowing easy installation for virtually every application. This durable tie rod cylinder design allows customers to achieve maximum productivity desired with low friction.

#### Accurate Rod Guiding

High-performance self lubricating bearing and non-abrasive wiper seal

#### Precise Cushion Adjustment

via the micrometer captive screw design

#### Light and Aesthetic Design

Stainless steel tie rod construction with hard anodized aluminium tube

#### Position Detector

Cylinder equipped with a piston with a permanent magnet, for position sensors, type:

- REED switch
- Hall Effect Sensor

#### Sturdy Design

Hard chrome plated piston rod

#### Easy Fitting

Large choice of standard fittings and rod ends (see below)

#### Easy Maintenance

These cylinders do not require any lubrication.

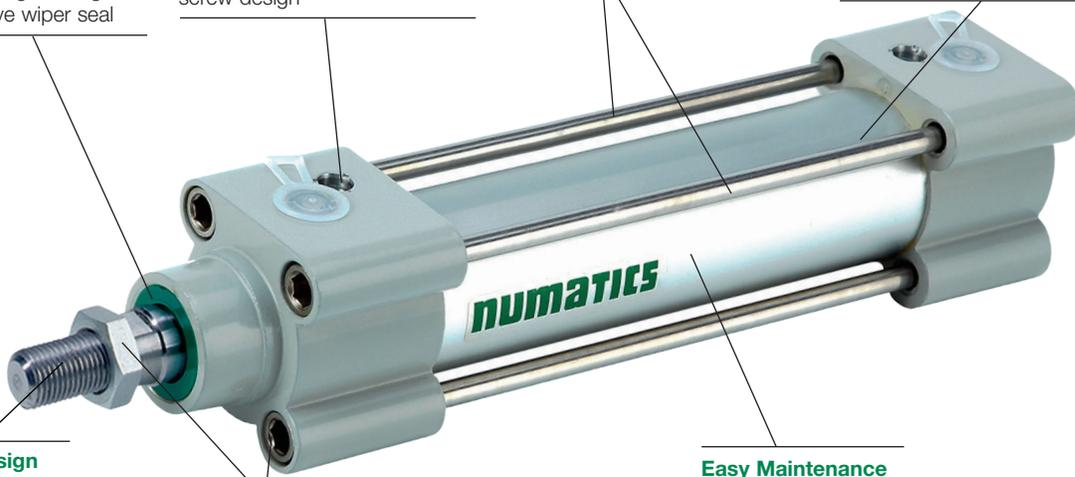

### General

<b>Detection</b>	Equipped for magnetic position detectors
<b>Fluid</b>	Compressed Air
<b>Max. Operating pressure</b>	145 psi (10 Bar)
<b>Ambient temperature</b>	-4°F to + 158°F (-20°C to + 70°C)
<b>Optimal max. speed</b>	≤ 1 m/s (for optimal service life)
<b>Max. speed rate</b>	2 m/s
<b>Standards</b>	ISO 15552

### Construction

<b>Tube</b>	Hard anodized aluminium alloy	
<b>Tie Rods</b>	Stainless steel	
<b>Head and Cap</b>	Aluminium alloy	
<b>Bearing</b>	Self-lubricating metal	
<b>Cushioning Seals</b>	PUR (polyurethane)	
<b>Cushioning</b>	Pneumatic, adjustable from both sides with captive screw	
<b>Piston Rod</b>	Hard chrome plated steel	
<b>Rod Nut</b>	Galvanised steel	
<b>Piston</b>	Ø 32 to 80 mm	POM (polyacetal)
	Ø 100	light alloy
	fitted with an annular reed magnet	
<b>Piston Seals</b>	PUR (polyurethane)	

### How to Order

**G 450 A 3 S K 0050 A00**

#### Thread Connection

G = ISO 228/1

#### Product Series

450 Series

#### Revision Letter

A = Revision Level

#### Bore (mm)

3 = 32  
4 = 40  
5 = 50  
6 = 63  
8 = 80  
1 = 100

#### Cylinder Type

S = Single Rod, Double Acting  
2 = Double Rod, Double Acting  
3 = 303 Stainless Steel Single Rod, Double Acting  
4 = 303 Stainless Steel Double Rod, Double Acting

#### Rod Option

K = Standard  
R = Prepped for Rod Lock (Rod Lock Not Included)  
S = With Rod Lock (Assembled Onto Cylinder)

#### Options

A00 = No Option  
C01 = Foot Bracket (Outside) Mount  
C03 = Foot Bracket (Inside) Mount  
C07 = Oscillating Bracket with Lugs  
C08 = Oscillating Bracket with Wide Fork Type Mount  
C13 = Spherical Eye Mount (Back Side)  
C14 = Oscillating Bracket with Narrow Fork Type Mount  
CD4 = Rod Clevis Mount Both Ends (Double Rod)  
CD5 = Spherical Eye Mount Both Sides (Double Rod)  
CF2 = Front Flange Mount  
CF4 = Rod Clevis Mount  
CF5 = Spherical Rod Eye Mount (Front Side)  
CR2 = Rear Flange Mount  
FMT = Fixed Mid Trunnion (Axis Perpendicular to Ports)<sup>1</sup>  
FST = Fixed Mid Trunnion (Axis Parallel to Ports)<sup>1</sup>  
MS3 = High Foot Mount  
AB7 = Angular Clevis Bracket  
AB5 = Angular Clevis Bracket Spherical Bearing  
CF6 = Alignment Compensator  
01A = Front Rod Extension  
01B = Rear Rod Extension  
02A = Front Thread Extension  
02B = Rear Thread Extension

#### Recommended Standard Strokes (mm)

0005 = 5mm (Minimum Stroke)  
2000 = 2000mm (Maximum Stroke)

<sup>1</sup> For fixed supplied mid trunnion, consult our Dynamic Product Modeling Tool on [www.numaticsnet.com](http://www.numaticsnet.com) and indicate XV dimension.



## Dimensions: mm

### Single Rod Cylinder

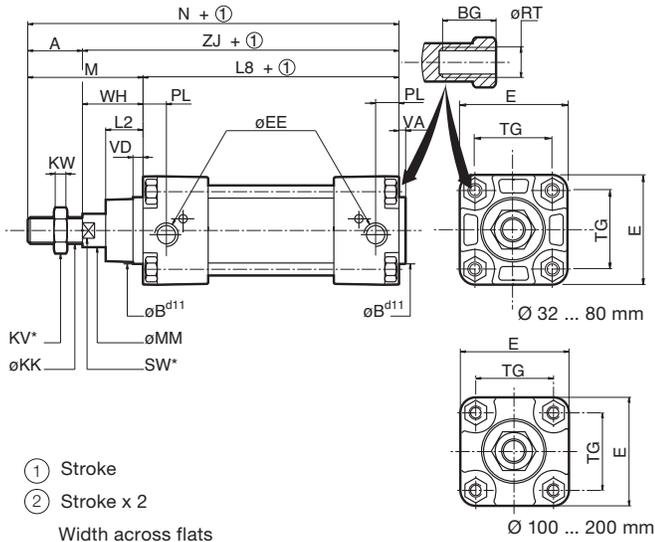

### Double Rod Cylinder

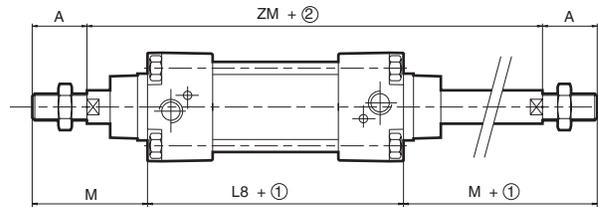

Ø (mm)	A	ØBd11	BG	E	ØEE	ØKK	KV	KW	L2	L8	M	ØMM	N	PL	ØRT	SW (5)	TG	VA	VD min.	WH	ZJ	ZM	Weight (kg)	
																							Base	Stroke Adder (mm)
32	22	30	16	50	G1/8	M10x1.25	16	5	17	94	48	12	142	14	M6x1	10	32.5	4	4	26	120	146	0.590	0.235
40	24	35	16	57.5	G1/4	M12x1.25	18	6	19	105	54	16	159	16	M6x1	13	38	4	4	30	135	165	0.840	0.335
50	32	40	16	65	G1/4	M16x1.5	24	8	24	106	69	20	175	18.5	M8x1.25	17	46.5	4	4	37	143	180	1.200	0.510
63	32	45	16	79	G3/8	M16x1.5	24	8	24	121	69	20	190	17	M8x1.25	17	56.5	4	4	37	158	195	1.500	0.540
80	40	45	17	100	G3/8	M20x1.5	30	10	33	128	86	25	214	16.5	M10x1.5	22	72	4	4	46	174	220	2.860	0.840
100	40	55	17	120	G1/2	M20x1.5	30	10	35.5	138	91	25	229	21	M10x1.5	22	89	4	4	51	189	240	3.675	1.185



### 453 Series

The 453 Series is an aluminum body air cylinder that is designed to meet all ISO 15552 requirements. The 453 Series is a lighter and modern-looking cylinder with a sturdy tie rod design inside for optimal technical performance.

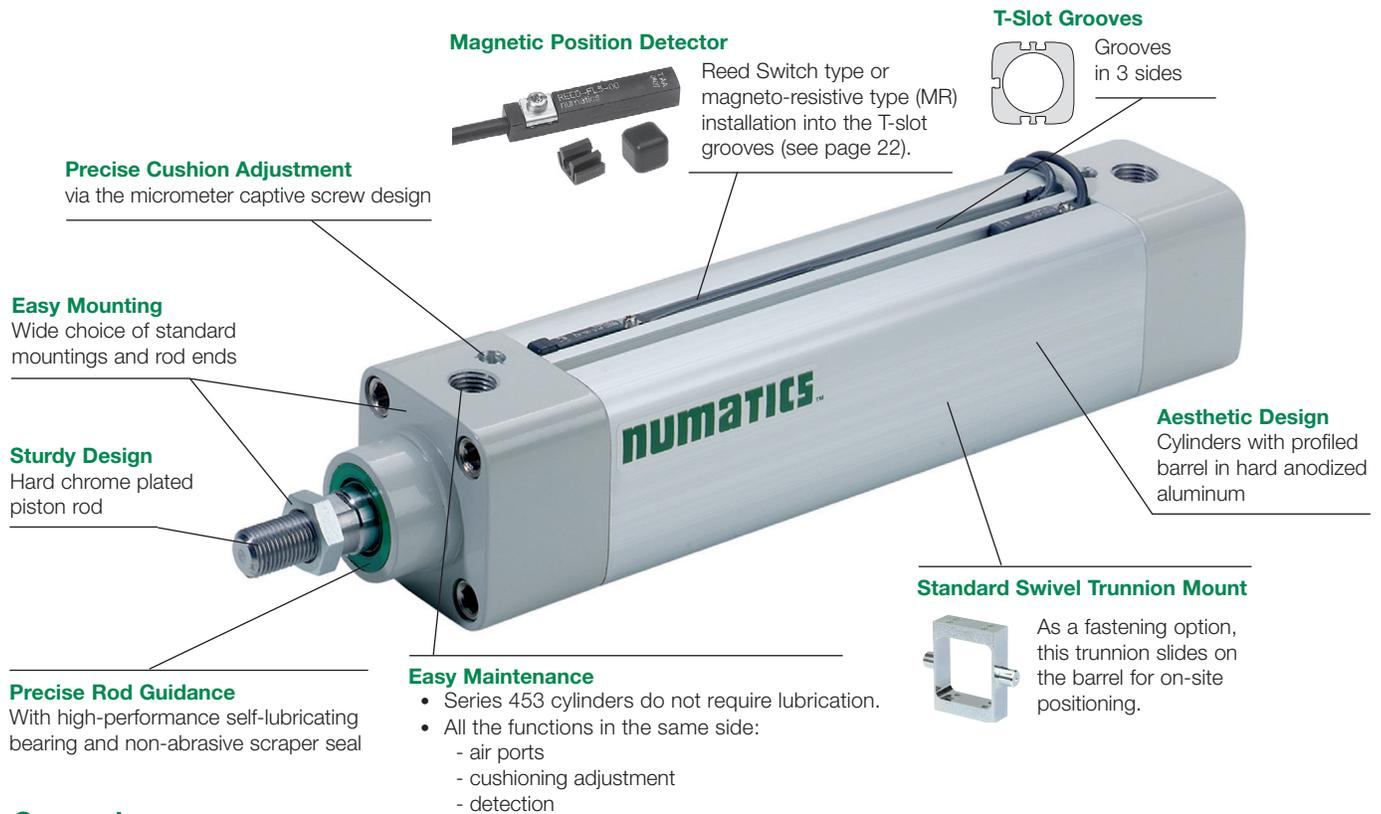

### General

<b>Detection</b>	Equipped for magnetic position sensors
<b>Fluid</b>	Compressed Air
<b>Operating Pressure</b>	10 bar max./150 PSI
<b>Ambient Temperature</b>	-20°C to +70°C (°4F to 158°F)
<b>Optimal Max Speed</b>	≤ 1 m/s (for optimal service life)
<b>Max. Speed Rate</b>	2 m/s
<b>Standards</b>	ISO 15552

### Construction

<b>Tube</b>	Hard anodized aluminium alloy	
<b>Head and Cap</b>	Aluminium alloy	
<b>Bearing</b>	Self-lubricating metal	
<b>Cushioning Seals</b>	PUR (polyurethane)	
<b>Cushioning</b>	Pneumatic, adjustable from both sides with captive screw	
<b>Piston Rod</b>	Hard chrome plated steel	
<b>Rod Nut</b>	Galvanized steel	
<b>Piston</b>	Ø 32 to 80 mm	POM (polyacetal)
	Ø 100 mm	light alloy
	Fitted with an annular Reed magnet	
<b>Piston Seals</b>	PUR (polyurethane)	

### How to Order

**G 453 A 3 S K 0050 A00**

**Thread Connection**

G = ISO 228/1

**Product Series**

453 Series

**Revision Letter**

A = Revision Level

**Bore (mm)**

3 = 32  
4 = 40  
5 = 50  
6 = 63  
8 = 80  
1 = 100

**Cylinder Type**

S = Single Rod, Double Acting  
2 = Double Rod, Double Acting  
3 = 303 Stainless Steel Single Rod, Double Acting  
4 = 303 Stainless Steel Double Rod, Double Acting

**Rod Option**

K = Standard  
R = Prepped for Rod Lock (Rod Lock Not Included)  
S = With Rod Lock (Assembled Onto Cylinder)

**Options**

A00 = No Option  
C01 = Foot Bracket (Outside) Mount  
C03 = Foot Bracket (Inside) Mount  
C07 = Oscillating Bracket with Lugs  
C08 = Oscillating Bracket with Wide Fork Type Mount  
C13 = Spherical Eye Mount (Back Side)  
C14 = Oscillating Bracket with Narrow Fork Type Mount  
CD4 = Rod Clevis Mount Both Ends (Double Rod)  
CD5 = Spherical Eye Mount Both Sides (Double Rod)  
CF2 = Front Flange Mount  
CF4 = Rod Clevis Mount  
CF5 = Spherical Rod Eye Mount (Front Side)  
CR2 = Rear Flange Mount  
MS4 = Mid Trunnion Mount (Axis Parallel to Port)  
MT4 = Mid Trunnion Mount (Axis Perpendicular to Port)  
AB7 = Angular Clevis Bracket  
AB5 = Angular Clevis Bracket Spherical Bearing  
CF6 = Alignment Compensator  
01A = Front Rod Extension  
01B = Rear Rod Extension  
02A = Front Thread Extension  
02B = Rear Thread Extension

**Recommended Standard Strokes (mm)**

0005 = 5mm (Minimum Stroke)  
2000 = 2000mm (Maximum Stroke)

Extended piston rod, consult us.



Dimensions: mm

### Single Rod Cylinder

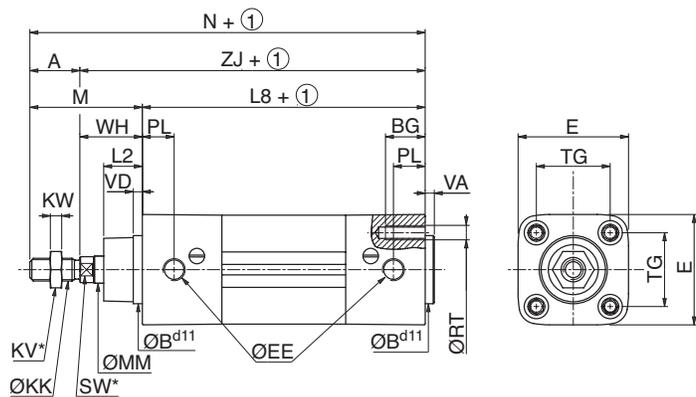

### Double Rod Cylinder

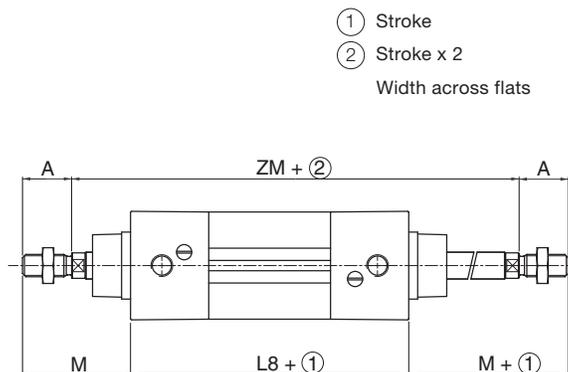

- ① Stroke
- ② Stroke x 2
- Width across flats

Bore Ø (mm)	A	ØB <sup>d11</sup>	BG	E	ØEE (3)	ØKK	KV	KW	L2	L8	M	ØMM	N	PL	ØRT	SW	TG	VA	VD min.	WH	ZJ	ZM	Weight (kg)	
																							Base	Stroke Adder (mm)
32	22	30	16	48	G1/8	M10x1.25	16	5	17	94	48	12	142	14	M6x1	10	32.5	4	4	26	120	146	0.49	0.0029
40	24	35	16	54	G1/4	M12x1.25	18	6	19	105	54	16	159	16	M6x1	13	38	4	4	30	135	165	0.78	0.0037
50	32	40	16	66	G1/4	M16x1.5	24	8	24	106	69	20	175	18.5	M8x1.25	17	46.5	4	4	37	143	180	1.00	0.0053
63	32	45	16	78	G3/8	M16x1.5	24	8	24	121	69	20	190	19	M8x1.25	17	56.5	4	4	37	158	195	1.35	0.0057
80	40	45	17	96	G3/8	M20x1.5	30	10	33	128	86	25	214	16.5	M10x1.5	22	72	4	4	46	174	220	2.36	0.0086
100	40	55	17	115	G1/2	M20x1.5	30	10	35.5	138	91	25	229	19.5	M10x1.5	22	89	4	4	51	189	240	3.46	0.0099

Thread connections G have standard thread according to ISO 16030.

**453 Series Slide**

Utilizing ISO cylinders, these guide units offer high load carrying capabilities.

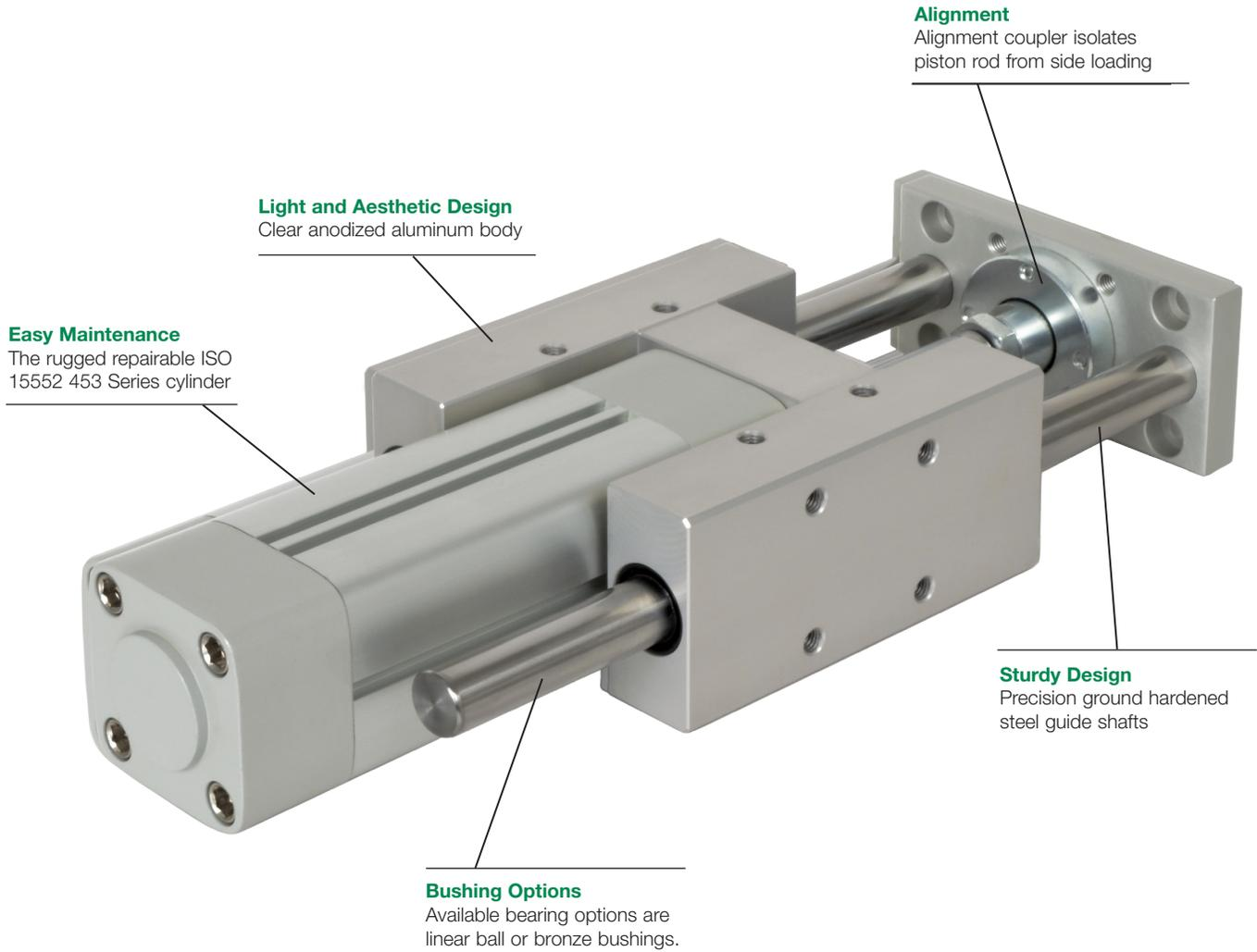

### How to Order Complete Guide Units (Guide Units Include Cylinder)

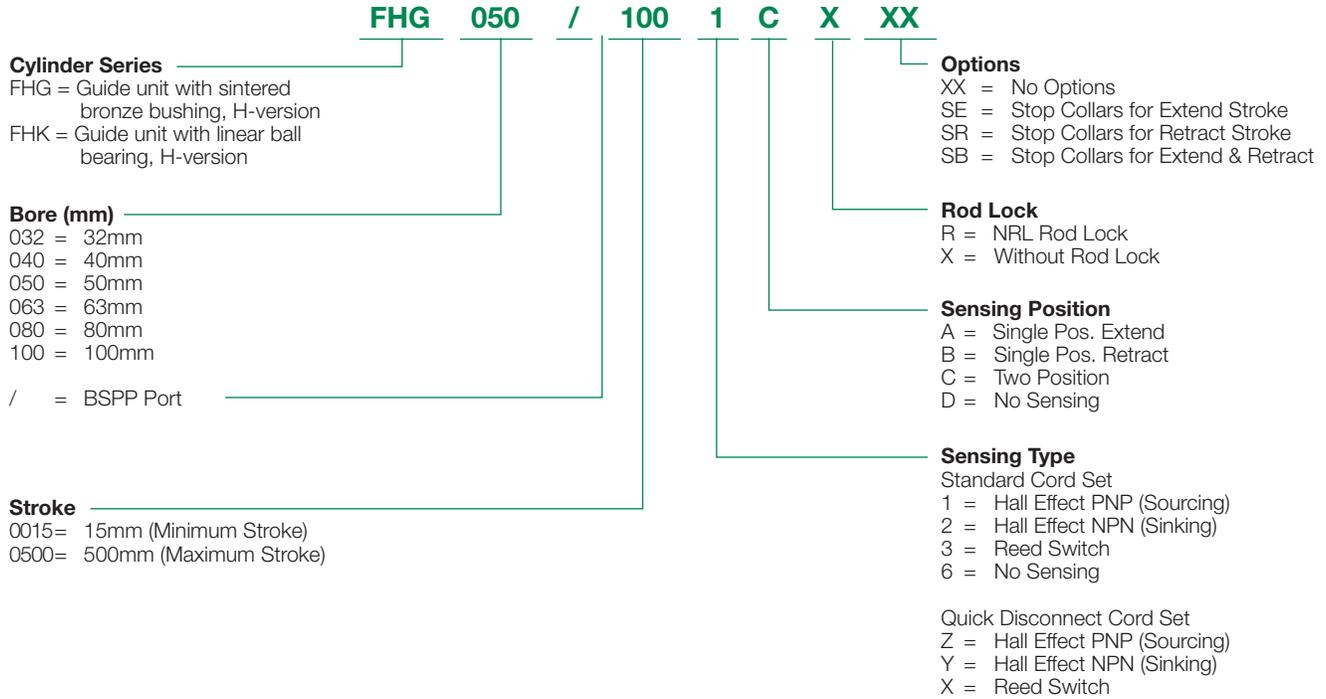

### Weights: Kg

Type FHG; Piston Diameter (mm)	32	40	50	63	80	100
0 mm stroke	1.30	2.40	3.50	4.60	8.40	11.8
To be added per 100 mm stroke	0.17	0.31	0.50	0.50	0.77	0.77

Type FHK; Piston Diameter (mm)	32	40	50	63	80	100
0 mm stroke	1.30	2.40	3.50	4.60	8.40	11.8
To be added per 100 mm stroke	0.17	0.31	0.50	0.50	0.77	0.77

Lbs. = Kg X 2.205  
 Weights for guide unit only.

**Maximum permissible loads in relation to stroke**

FHG Sintered Bronze bushing  
Static ratings (Dynamic = load X .5)

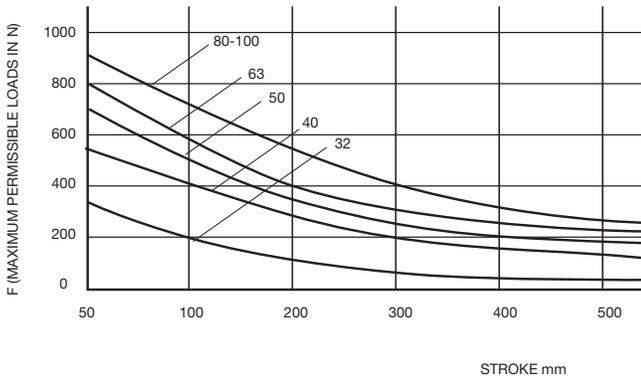

FHK Linear Ball  
Static ratings (Dynamic = load X .65)

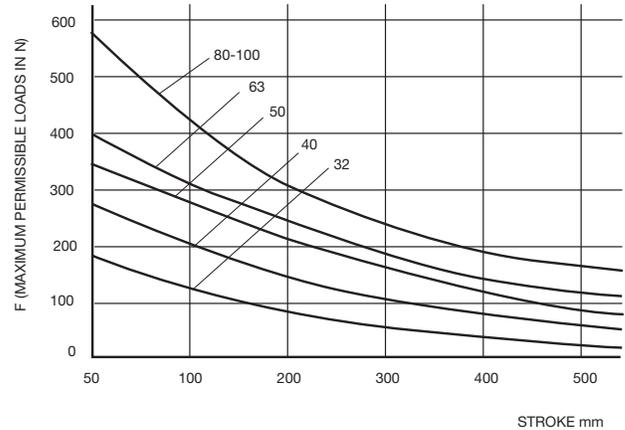

FHG: Guide unit, long, with sintered bronze bushing  
FHK: Guide unit, long, with linear ball bearing

- With short strokes up to 60 mm, a reduction of load with linear ball bearings occurs. This is already taken into account in the diagrams.
- Increasing of max. load by 25% results in a reduction of lifetime of linear ball bearing to  $2 \times 10^6$  m.
- For shock applications with linear ball bearings multiply load capacity by factor 0.5.

FHG: Guide unit, long, with sintered bronze bushing  
FHK: Guide unit, long, with linear ball bearing

- The total deflection of the guide rods against rod projection is the sum of deflection by own weight and deflection by load.
- Deflection in function of load is linear (with double load double deflection).

$F1 = F \times 0.9N$

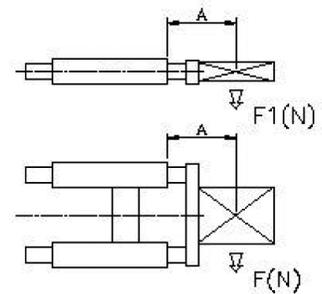

### Guide Units

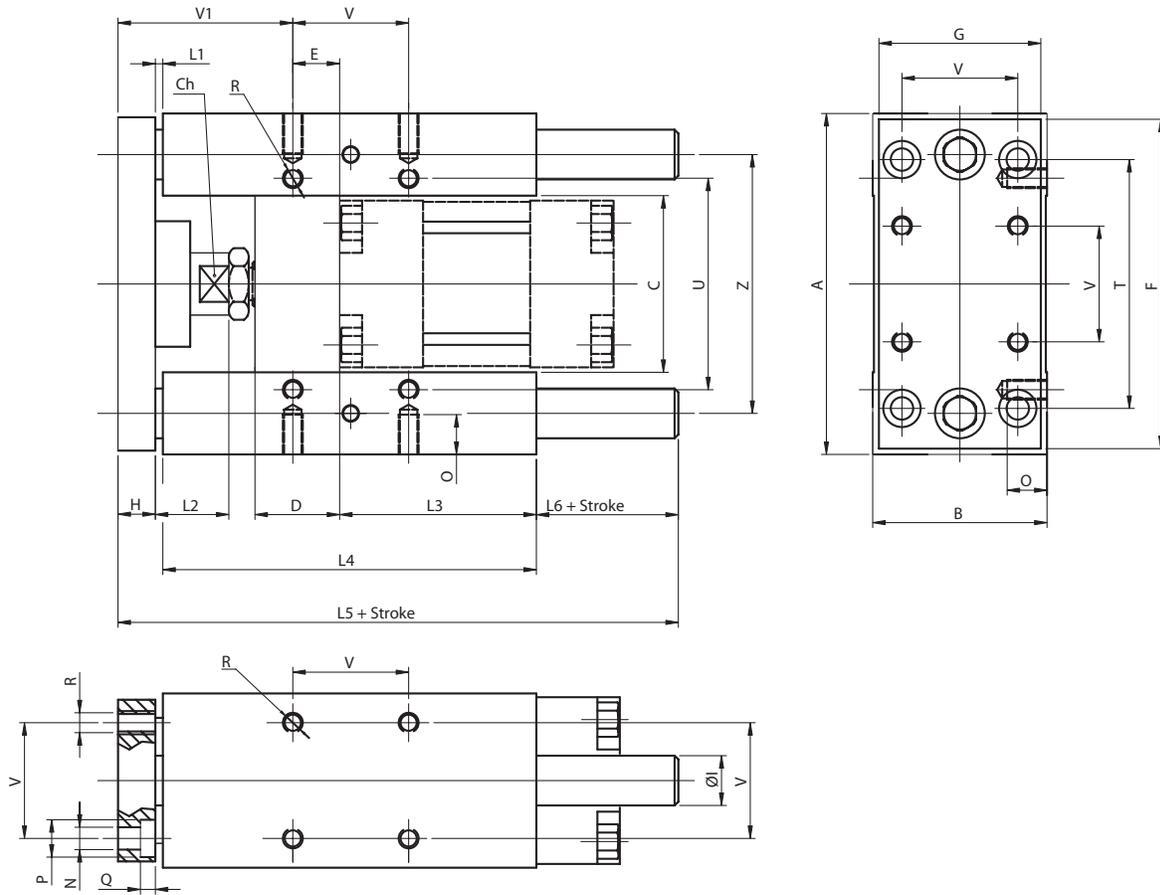

Bore Ø (mm)	A	B	C	Ch	D	E	F	G	H	ØI	L1*	L2	L3	L4	L5*	L6
32	97	49	51	15	24	4.3	93	45	12	12	3	19	75	125	187	47
40	115	58	58.2	15	28	11	112	55	12	16	3	24	80	140	207	52
50	137	70	70.2	20	34	18.8	134	65	15	20	3	27	78	148	223	57
63	152	85	85.2	20	34	15.3	147	80	15	20	3	27	106	178	243	47
80	189	105	105.5	26	50	25	180	100	20	25	3	27	111	195	267	49
100	213	130	130.5	26	55	30	206	120	20	25	3	27	128	218	290	49

\*Add an additional 22 mm when ordered with retract stop collars.

Bore Ø (mm)	N	O	P	Q	R	T	U	V	V1*	Z
32	6.6	12	11	6.5	M6x1	78	61	32.5	60.7	74
40	6.6	12	11	6.5	M6x1	84	69	38	64	87
50	9	16	15	8.5	M8x1.25	100	85	46.5	70	104
63	9	16	15	9	M8x1.25	105	100	56.5	74.7	119
80	11	20	18	11	M10x1.5	130	130	72	82	148
100	11	20	18	11	M10x1.5	150	150	89	83	173

**NRL Series Rod Lock**

**Numatics new generation of linear holding/locking devices take rod locking technology to the next level. With superior performance, these spring-engaged, air-released units supplement air cylinders and guide rods for holding in power-off/e-stop situations. High clamping forces ensure positive holding with minimal air required for release. Choose from our standard products, or we will work with you to meet your unique application specifications.**



Numatics A Series NFPA Interchangeable Cylinder with NRL Series Rod Lock Assembled.



**Precision Operation Maintains Accurate Positioning**

The NRL Series of Rod Locks guarantees accurate positioning and provides precision holding while other operations are performed. The Rod Lock engages without causing any rod displacement, and also features extremely low backlash making them ideal for precision applications.

**Large Clamping Surface Ensures Consistent Performance**

The NRL line is designed with a large clamping surface that provides uniform force to the rod contact area on every engagement. The clamping mechanism utilizes numerous ball bearing to reduce friction.

**Spring-engaged Units Engage in Power-off Situations**

Numatics Rod Locks are spring-engaged, so they operate even in power-off situations. Multiple springs ensure reliable performance and redundancy. The fast response time of these spring-engaged products also increases positioning accuracy. Numatics Rod Locks also feature locking mode sensing capability that allows engagement/disengagement feedback with the use of an optional inductive sensor.

**Sealed to Withstand Harsh Environments**

Every NRL Rod Lock is sealed to protect internal components. These seals are designed to withstand even harsh wash-down environments and are IP67/ NEMA 4X rated. Rod Locks are available in natural clear anodized aluminum or with a black anodized coating.

**Manual Release**

The cam operated manual release feature mechanically disengages the rod lock with the simple turn of a hex screw using a standard wrench. The default-to-lock function springs back to the engaged position when released.

**CAUTION:** This static rod lock is suitable for infrequent dynamic braking (emergency stops) when used with hardened shaft material. Repeated dynamic stops may cause rod and/or collar wear, reducing holding forces.



Numatics Static Rod Locks deliver precision holding with virtually no backlash, providing high accuracy in demanding applications. These spring-engaged, air-released units come in both ISO and NFPA sizes and will accept standard accessories.

The Rod Lock's large clamping surface ensures high clamping/holding force. Customers can further increase holding forces by stacking multiple Rod Locks together. The patent pending design is sealed and features a natural clear anodized aluminum finish or a corrosion-resistant, anodized finish. Whatever your application, precision operation with hassle-free performance come standard with each compact unit.

### Applications

- Machine Tools
- Hydraulic Presses
- Scissor-Lift Tables
- Positioning Equipment
- Amusement Ride Equipment
- Printing & Paper Handling Equipment
- Theatrical Equipment (platforms)
- Injection Molding Machines
- Automation Equipment
- Elevators and Lifts
- Mining Applications

### Rod Lock Cutaway

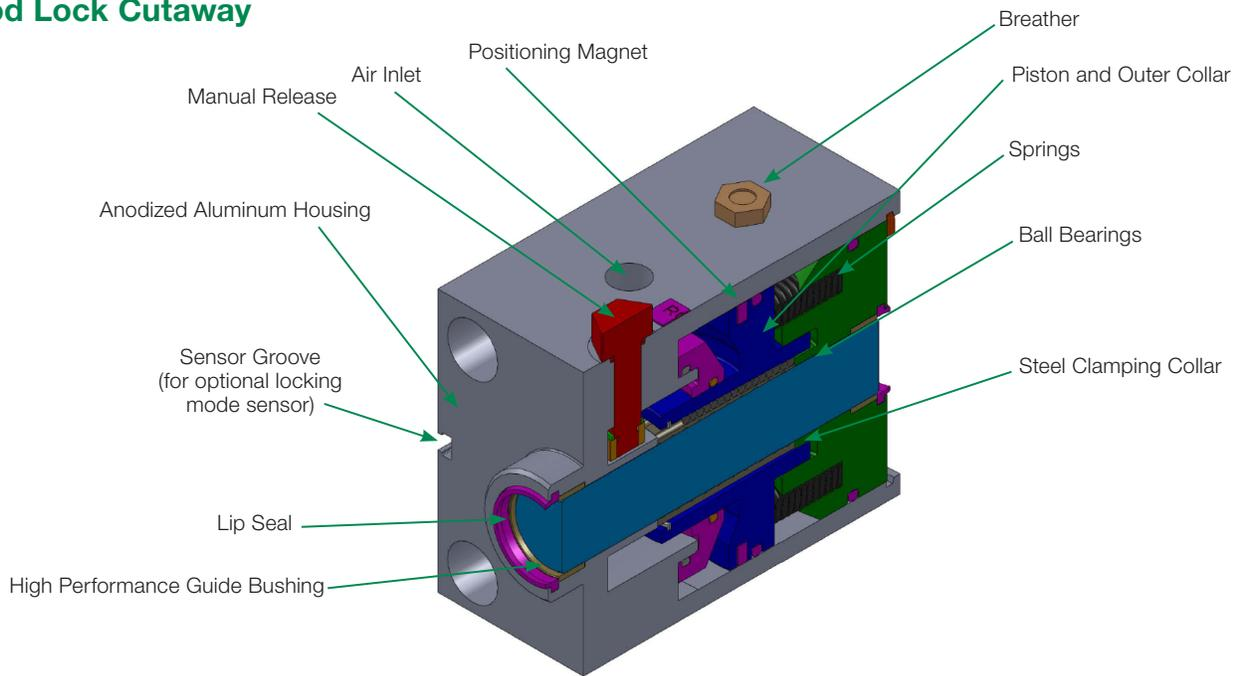

Features	Benefits
No Rod Displacement on Engagement	Maintains Accurate Positioning
Large Clamping Surface	Consistent Clamping Force
IP67 Rated [exceeds NEMA 4X]	Suitable for Wash-Down Areas
Fast Response Time	High Cycle Rates, Accuracy
Extremely Low Backlash	Precision Holding
Spring-Engaged Units	Holds Load During Power/Pressure Loss
Profile Matches Cylinder	Compact Unit, Easy Integration
60 psi Release Pressure	Broad Application
Manual Release	Release Without Air Pressure
Sensor (Optional)	Detects Locking Mode

**Numatics Rod Locks**

Numatics cylinder mounted NRL Rod Locks match the cylinder profiles for easy, compact integration.

**Cylinder Requirements**

- Extra length = rod extension required (RE) – cylinder pilot length (see below)
- RE = Rod Extension
- Mounting bolts included with ISO and NFPA\*
- **Operating dynamic forces must not exceed the static holding force**

\*With the exception of the NFPA 8" bore, where extended tie rods and hex nuts are used.



Numatics 453 Series ISO 15552 Interchangeable Cylinder with NRL Series Rod Lock Assembled.

**Numatics Rod Lock Specifications**

**NFPA Rod Locks (in)\***

Bore Ø	Rod Ø	Holding Force (lbs)	Rod Extension (RE)
1.500	0.625	180	2.625
2.000	0.625	314	2.875
2.000	1.000	250	3.875
2.500	0.625	491	2.875
3.250	1.000	830	4.500
3.250	1.375	830	4.875
4.000	1.000	1,256	4.875
4.000	1.375	1,256	5.125
5.000	1.000	1,963	5.375
5.000	1.375	1,963	5.750
6.000	1.375	2,830	6.375
6.000	1.750	2,830	6.875
8.000	1.750	5,026	7.125

\* Dimensions shown in inches

**ISO Rod Locks (mm)\***

Bore Ø	Rod Ø	Holding Force (N)	Rod Extension (RE)
32	12	800	70
40	16	890	75
50	20	1,400	98
63	20	2,225	97
80	25	3,560	116
100	25	5,500	127

\* Dimensions shown in millimeters

**Locking Mode Sensors**

NPN Flying Leads	P494A0022400A00
NPN w/ a Quick Disconnect	P494A0022700A00
PNP Flying Leads	P494A0022300A00
PNP w/ Quick Disconnect	P494A0022600A00

### Rod Lock Operation Specifications

- All of Numatics Rod Locks will operate in both directions, engaging with the same holding force.
- Rod Locks can be mounted in any position.
- Rod rotation is not allowed when a Rod Lock is engaged (not intended for torsional braking).
- Release pressures can range from 60-120 psi (4-8 bar).
- The Buna-N seals used are rated to 160°F (71°C).
- Allowable operating temperatures range from 33°F-150°F (0.5°C-66°C).

### Rod Lock Air Chamber Volume & Engagement Time

#### NFPA Rod Locks (in)\*

Bore Ø	Rod Ø	Air Chamber Volume	Approximate Engagement Time (seconds)
1.500	0.625	0.250in <sup>3</sup>	0.030
2.000	0.625	0.710in <sup>3</sup>	0.040
2.000	1.000	0.680in <sup>3</sup>	0.040
2.500	0.625	1.260in <sup>3</sup>	0.045
3.250	1.000	3.200in <sup>3</sup>	0.070
3.250	1.375	2.110in <sup>3</sup>	0.060
4.000	1.000	6.730in <sup>3</sup>	0.100
4.000	1.375	4.780in <sup>3</sup>	0.100
5.000	1.000	11.500in <sup>3</sup>	0.150
5.000	1.375	9.500in <sup>3</sup>	0.130
6.000	1.375	14.080in <sup>3</sup>	0.175
6.000	1.750	12.750in <sup>3</sup>	0.165
8.000	1.750	23.210in <sup>3</sup>	0.265

\* Dimensions shown in inches

#### ISO Rod Locks (mm)\*

Bore Ø	Rod Ø	Air Chamber Volume	Approximate Engagement Time (seconds)
32	12	4.750cm <sup>3</sup>	0.030
40	16	6.720cm <sup>3</sup>	0.030
50	20	9.180cm <sup>3</sup>	0.035
63	20	13.440cm <sup>3</sup>	0.045
80	25	31.950cm <sup>3</sup>	0.060
100	25	112.740cm <sup>3</sup>	0.100

\* Dimensions shown in millimeters

**NFPA How to Order**

A Series cylinders with "NX" in the option code include the NRL Series rod lock unit assembled to the cylinder. Note that the cylinder includes the correct amount of rod extension.

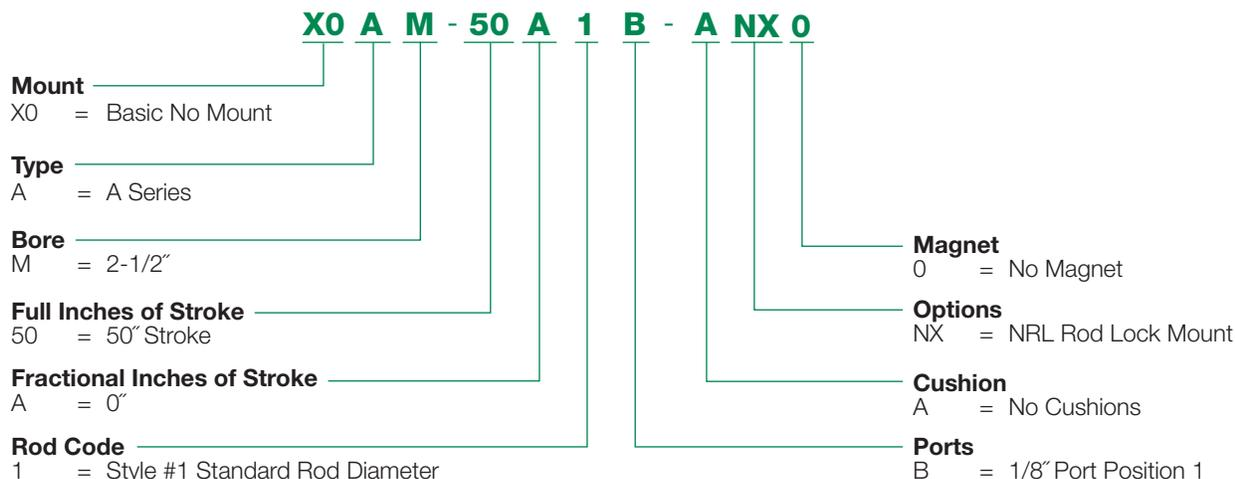

**NFPA Examples**

- A Series            X0AR-25A1B-ANX0
- EQ Series         F1EQR-50A4O-GNX2

**ISO 15552 How to Order**

ISO 15552 cylinders with "R" in the "Rod Option" code, will include the rod lock unit separate to the cylinder. Cylinders with "S" in the "Rod Option" code, will include the rod lock unit assembled to the cylinder. Please note that the cylinder includes the correct amount of rod extension.

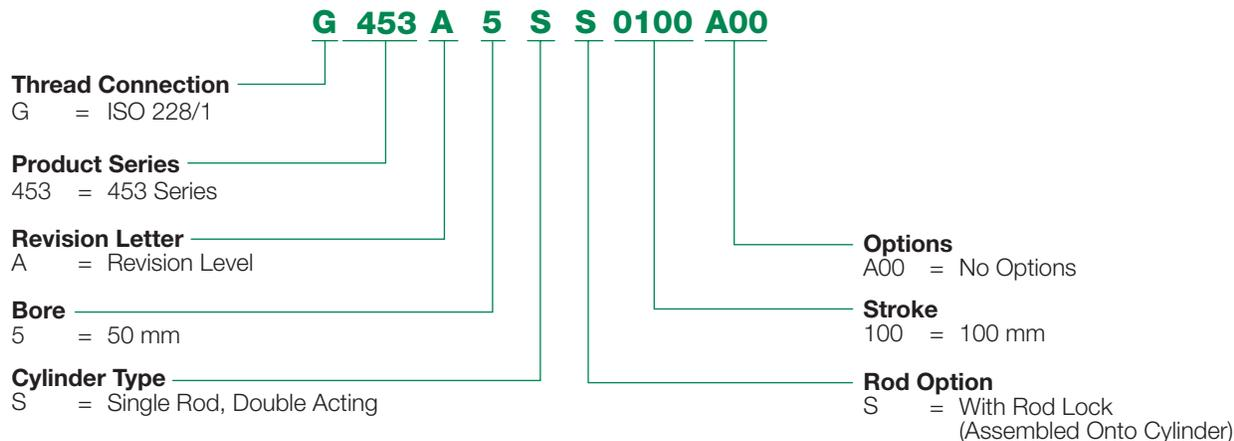

**ISO Examples**

- 453 Series            G453A3SR0025A00
- 450 Series            G450A4SS0025A00

### Manual Release Rod Locks for NFPA and ISO Cylinders

#### Manual Release Specifications

- Cam operated, default to the lock function
- No special tools needed for manual disengagement, uses standard size hex head
- Steel Disengagement Screw
- Locking mode feedback sensor (optional/ see page 4)

#### NFPA Rod Locks (in)\*

Bore Ø	Rod Ø	Air Chamber Volume (in <sup>3</sup> )	Approximate Engagement Time (seconds)	Holding Force (lbs)	Minimum Torque to Override (ft-lbs)
1.500	0.625	0.250in <sup>3</sup>	0.030	180	2
2.000	0.625	0.710in <sup>3</sup>	0.040	314	5
2.000	1.000	0.680in <sup>3</sup>	0.040	250	5
2.500	0.625	1.260in <sup>3</sup>	0.045	491	7
3.250	1.000	3.200in <sup>3</sup>	0.070	830	17
3.250	1.375	2.110in <sup>3</sup>	0.060	830	17
4.000	1.000	6.730in <sup>3</sup>	0.100	1,256	45
4.000	1.375	4.780in <sup>3</sup>	0.100	1,256	45
5.000	1.000	11.500in <sup>3</sup>	0.150	1,963	72
5.000	1.375	9.500in <sup>3</sup>	0.130	1,963	72
6.000	1.375	14.080in <sup>3</sup>	0.175	2,830	135
6.000	1.750	12.750in <sup>3</sup>	0.165	2,830	135
** 8	1.750	23.210in <sup>3</sup>	0.265	5,026	160

\* Dimensions shown in inches

\*\* These products do not have locking mode T slot provisions.

#### ISO Rod Locks (mm)\*

Bore Ø	Rod Ø	Air Chamber Volume (cm <sup>3</sup> )	Approximate Engagement Time (seconds)	Holding Force (N)	Minimum Torque to Override (N-m)
32	12	4.750cm <sup>3</sup>	0.030	800	3
40	16	6.720cm <sup>3</sup>	0.030	890	3
50	20	9.180cm <sup>3</sup>	0.035	1,400	7
63	20	13.440cm <sup>3</sup>	0.045	2,225	12
80	25	31.950cm <sup>3</sup>	0.060	3,560	22
100	25	112.740cm <sup>3</sup>	0.100	5,500	65

\* Dimensions shown in millimeters

**Rod Locks with Manual Release for NFPA and ISO Cylinders, Dimensions**

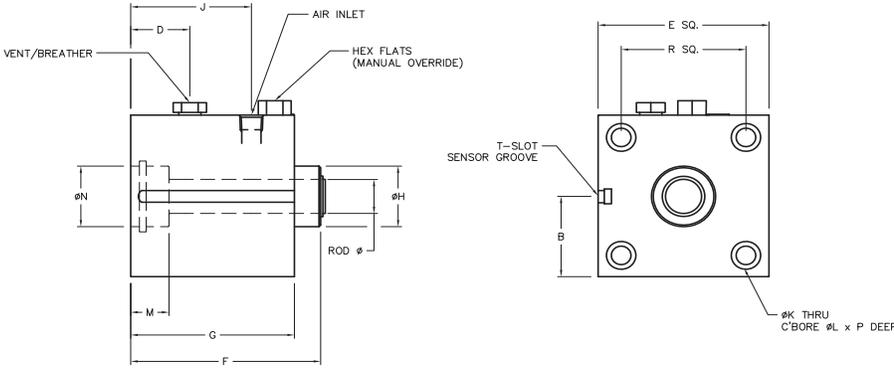

**NFPA Rod Locks (in)\***

Bore Ø	Rod Ø	B (to slot)	D	E	F	G	H Ø	J	K Ø	L Ø	M	N Ø	P	R	NPT Air Inlet	Hex Flats
1.500	0.625	0.990	1.005	2.000	3.000	2.625	1.124/1.122	1.906	0.281	0.438	0.652	1.128/1.126	0.910	1.430	1/8 NPT	0.313
2.000	0.625	1.240	1.005	2.500	3.250	2.875	1.124/1.122	1.975	0.344	0.516	0.673	1.128/1.126	1.030	1.840	1/8 NPT	0.500
2.000	1.000	1.240	1.674	2.500	4.375	3.875	1.499/1.497	2.814	0.344	0.516	0.902	1.503/1.501	1.030	1.840	1/8 NPT	0.500
2.500	0.625	1.490	1.039	3.000	3.375	2.875	1.124/1.122	2.119	0.344	0.516	0.673	1.128/1.126	1.030	2.190	1/8 NPT	0.500
3.250	1.000	1.865	1.374	3.750	5.000	4.500	1.499/1.497	2.992	0.406	0.719	0.913	1.503/1.501	1.030	2.760	1/4 NPT	0.625
3.250	1.375	1.865	1.678	3.750	5.500	4.875	1.999/1.997	3.228	0.406	0.719	1.000	2.003/2.001	1.280	2.760	1/4 NPT	0.625
4.000	1.000	2.240	1.685	4.500	5.375	4.875	1.499/1.497	3.154	0.406	0.719	0.875	1.503/1.501	1.030	3.320	1/4 NPT	0.875
4.000	1.375	2.240	1.633	4.500	5.875	5.125	1.999/1.997	3.446	0.406	0.719	1.075	2.003/2.001	1.280	3.320	1/4 NPT	0.875
5.000	1.000	2.740	1.500	5.500	5.875	5.375	1.499/1.497	3.380	0.531	0.844	0.875	1.503/1.501	1.500	4.100	1/4 NPT	0.875
5.000	1.375	2.740	1.545	5.500	6.500	5.750	1.999/1.997	3.425	0.531	0.844	1.070	2.003/2.001	1.500	4.100	1/4 NPT	0.875
6.000	1.375	3.240	1.870	6.500	7.125	6.375	1.999/1.997	3.670	0.545	0.844	1.055	2.003/2.001	1.500	4.880	1/4 NPT	1.313
6.000	1.750	3.240	1.950	6.500	7.750	6.875	2.374/2.372	3.820	0.545	0.844	1.197	2.378/2.376	1.500	4.880	1/4 NPT	1.313
** 8	1.750	4.240	2.100	8.500	8.000	7.125	2.374/2.372	3.975	0.656	-	1.232	2.378/2.376	-	6.440	1/4 NPT	1.313

\*Dimensions shown in inches

\*\* These products do not have locking mode T slot provisions.

**ISO Rod Locks (mm)\***

Bore Ø	Rod Ø	B (to slot)	D	E	F	G	H Ø	J	K Ø	L Ø	M	N Ø	P	R	BSPP Air Inlet	Hex Flats
32	12	29.41	27.60	48.00	87.81	70.82	29.92/29.77	48.80	6.35	10.00	20.60	30.26/30.00	24.00	32.50	1/8 G	8.00
40	16	26.75	31.50	54.00	96.50	75.00	34.92/34.77	56.10	6.35	10.00	22.50	35.25/35.00	24.00	38.00	1/8 G	8.00
50	20	31.75	47.18	64.00	122.30	98.00	39.92/39.77	71.00	8.40	13.00	29.60	40.23/40.08	26.50	46.50	1/8 G	13.00
63	20	47.19	46.48	75.00	117.00	97.00	44.92/44.87	76.71	8.40	13.00	29.51	45.23/45.08	26.50	56.50	1/8 G	13.00
80	25	46.25	44.94	93.00	136.50	116.00	44.94/44.87	80.00	10.50	15.90	35.00	45.25/45.00	44.60	72.00	1/4 G	16.00
100	25	72.96	44.45	110.00	147.50	127.00	54.92/54.87	93.00	10.50	15.90	38.50	55.25/55.00	44.60	89.00	1/4 G	22.00

\* Dimensions shown in millimeters

## Mounting

Foot Bracket (Outside) Mount  
C01, C03

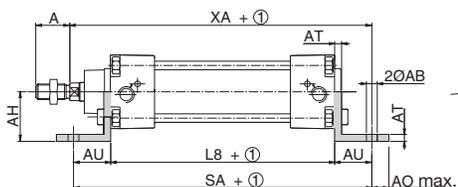

① Stroke

Bore Ø (mm)	ØAB	A	AO	AH	AT	AT1	AU	E	L8	SA	TR	TG	UF	US	XA	ZA	Weight (kg)
																	2 x Cø1
32	7	22	11	32	4	8	24	50	94	142	32	32.5	54	50	144	44	0.150
40	10	24	15	36	4	8	28	58	105	161	36	38	62	58	163	45	0.190
50	10	32	15	45	5	10	32	70	106	170	45	46.5	77	70	175	45	0.395
63	10	32	15	50	5	10	32	85	121	185	50	56.5	87	85	190	49	0.445
80	12	40	20	63	6	12	41	105	128	210	63	72	110	105	215	54	0.790
100	14.5	40	25	71	6	12	41	130	138	220	75	89	130	130	230	67	1.400

## Mounting

Front or Rear Flange  
CF2, CR2  
Rectangular

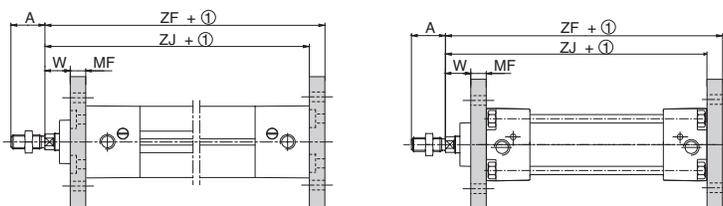

① Stroke

Bore Ø (mm)	A	ØD	E	ØFB	MF	R	TF	UF	W	ZB	ZJ	ZF	Weight (kg)
32	22	30	50	7	10	32	64	86	16	55	120	130	0.190
40	24	35	58	9	10	36	72	96	20	55	135	145	0.245
50	32	40	70	9	12	45	90	115	25	56	143	155	0.500
63	32	45	85	9	12	50	100	130	25	59.5	158	170	0.580
80	40	45	105	12	16	63	126	165	30	66.5	174	190	1.390
100	40	55	130	14	16	75	150	187	35	77.5	189	205	1.630

## Mounting

Mid Trunnion  
**MT4, MS4**  
 (Series 453)

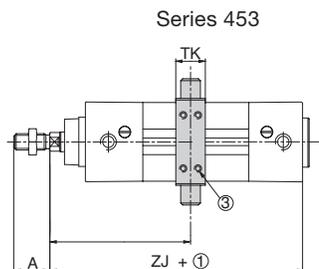

## Mounting

Fixed Mid Trunnion  
**FMT, FST**  
 (Series 450 and 453)

XV Dimension must be specified when ordering.

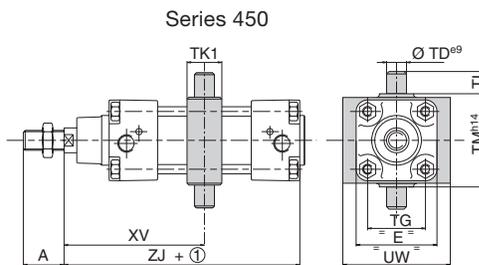

- ① Stroke
- ② The position of the trunnion may be adjusted along the unit. Consequently, the mid trunnion is not screwed on and must be adjusted after delivery.
- ③ 8 locking screws.

Bore Ø (mm)		A	E	TD	TG	TK	TK1	TL	TM	UW	UWA	ZB	ZJ	XV min.		XV max.		Weight (kg)	
														453	450	453	450	MT4, MS4 or FMT, FST	
453	450													453	450	453	450	453	450
32	32	22	56	12	32.5	18	22	12	53	55	64.5	55	120	71.5	72	75	74.5	0.185	0.2
40	40	24	67	16	38	20	28	16	63	58	74.5	55	135	81	83	84.2	82	0.33	0.4
50	50	32	89	16	46.5	20	28	16	75	68	91	56	143	89.5	89.5	91.3	91	0.475	0.5
63	63	32	89	20	56.6	25	35	20	90	84	94	59.5	158	89.5	93.5	102	102.5	0.57	0.9
80	80	40	112	20	72	25	35	20	110	102	130	66.5	174	106.5	106.5	114	114.5	1.12	1.1
100	100	40	112	25	89	30	40	25	132	145	145	87.5	189	116.5	114	124	126.5	1.52	1.86



## Rear Mounting

Oscillating Bracket with Wide Fork Type Mount  
**C08**

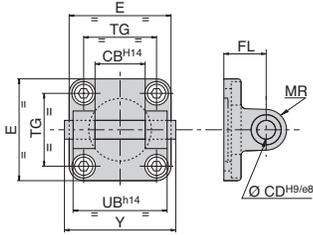

## Rear Mounting

Oscillating Bracket with Lugs  
**C07**

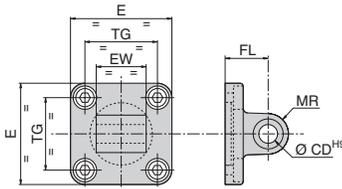

## Rear Mounting

Angular Clevis Bracket  
**AB7**

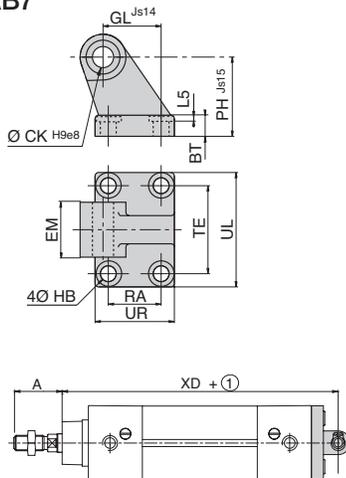

## C08 + C07

Oscillating Bracket with Wide Fork Type Mount  
+  
Oscillating Bracket with Lugs

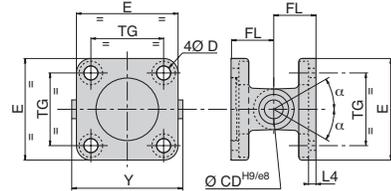

## C08 + AB7

Oscillating Bracket with Wide Fork Type Mount  
+  
Angular Clevis Bracket

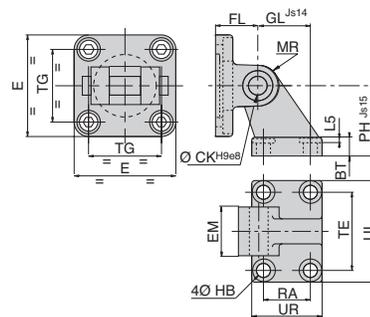

Bore Ø (mm)	Weight (kg)					
	Light Alloy			Cast Iron		
	C08	C07	AB7	C08	C07	AB7
32	0.105	0.085	0.16	0.205	0.21	0.34
40	0.15	0.092	0.23	0.305	0.23	0.45
50	0.24	0.17	0.39	0.43	0.43	0.79
63	0.37	0.25	0.57	0.685	0.62	1.08
80	0.635	0.445	0.95	1.375	1.1	2.09
100	0.99	0.755	0.5	2.1	1.7	2.75

Bore Ø (mm)	A	BT	CB EM	CD CK	D	E	EW	FL	GL	HB	L4	L5	MR	PH	RA	TE	TG	UB	UR	UL	XD	XE	Y
32	22	8	26	10	6.6	50	26	22	21	6.6	5.5	1.6	11	32	18	38	32.5	45	31	51	142	73	56
40	24	10	28	12	6.6	58	28	25	24	6.6	5.5	1.6	13	36	22	41	38	52	35	54	160	77	63
50	32	12	32	12	9	70	32	27	33	9	6.5	1.6	13	45	30	50	46.5	60	45	65	170	80	71
63	32	12	40	16	9	85	40	32	37	9	6.5	1.6	17	50	35	52	56.5	70	50	67	190	89	81
80	40	14	50	16	11	105	50	36	47	11	10	2.5	17	63	40	66	72	90	60	86	210	100	101
100	40	15	60	20	11	130	60	41	55	11	10	2.5	21	71	50	76	89	110	70	96	230	118	128

## Rear Mounting

Oscillating Bracket with Narrow Fork Type Mount  
C14

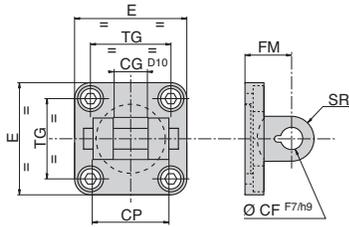

## C14 + C13

Oscillating Bracket with Narrow Fork Type Mount  
+ Spherical Eye Mount (Back Side)

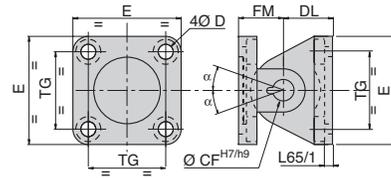

## Rear Mounting

Spherical Eye Mount (Back Side)  
C13

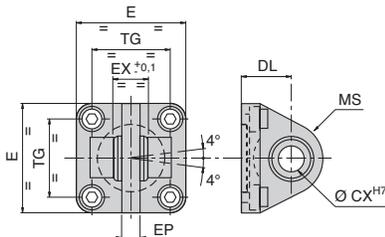

## C14 + AB5

Oscillating Bracket with Narrow Fork Type Mount  
+ Angular Clevis Bracket Spherical Bearing

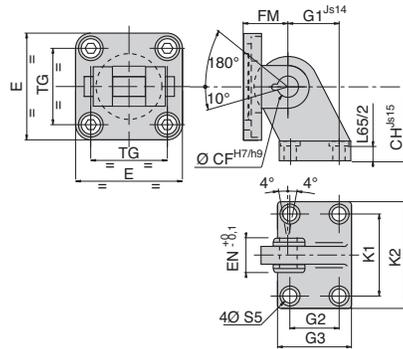

## Rear Mounting

Angular Clevis Bracket Spherical Bearing  
AB5

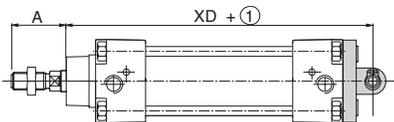
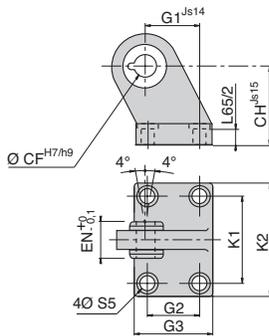

Bore Ø (mm)	A	BT	CB EM	CD CK	D	E	EW	FL	GL	HB	L4	L5	MR	PH	RA	TE	TG	UB	UR	UL	XD	XE	Y
32	22	8	26	10	6.6	50	26	22	21	6.6	5.5	1.6	11	32	18	38	32.5	45	31	51	142	73	56
40	24	10	28	12	6.6	58	28	25	24	6.6	5.5	1.6	13	36	22	41	38	52	35	54	160	77	63
50	32	12	32	12	9	70	32	27	33	9	6.5	1.6	13	45	30	50	46.5	60	45	65	170	80	71
63	32	12	40	16	9	85	40	32	37	9	6.5	1.6	17	50	35	52	56.5	70	50	67	190	89	81
80	40	14	50	16	11	105	50	36	47	11	10	2.5	17	63	40	66	72	90	60	86	210	100	101
100	40	15	60	20	11	130	60	41	55	11	10	2.5	21	71	50	76	89	110	70	96	230	118	128

## Rod Mount

Rod Clevis Mount  
CF4

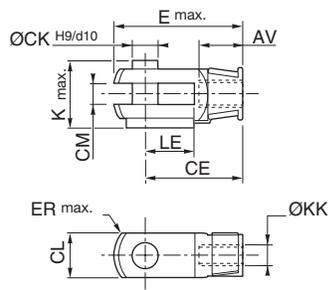

## Rod Mount

Spherical Rod Eye Mount (Front Side)  
CF5

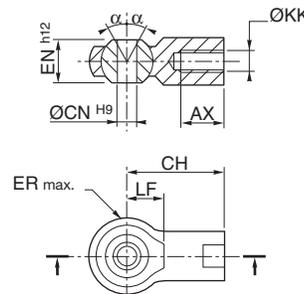

Bore Ø (mm)	AV AX	CE	CH	ØCK	CL	CM		ØCN	E max.	EN	ER max.	K	ØKK	LE	LF	Weight (kg)		
						Steel												
						CF4	CF5											
32	20	40	43	10	20	10	+ 0.5 / + 0.15	10	56	14	14	26	M10x1.25	20	15	4°	0.1	0.07
40	22	48	50	12	24	12	+ 0.5 / + 0.15	12	67	16	16	32	M12x1.25	24	17	4°	0.15	0.12
50	28	64	64	16	32	16	+ 0.5 / + 0.15	16	89	21	21	41	M16x1.5	32	22	4°	0.33	0.22
63	28	64	64	16	32	16	+ 0.5 / + 0.15	16	89	21	21	41	M16x1.5	32	22	4°	0.33	0.22
80	33	80	77	20	40	20	+ 0.5 / + 0.15	20	112	25	25	48	M20x1.5	40	26	4°	0.67	0.39
100	33	80	77	20	40	20	+ 0.5 / + 0.15	20	112	25	25	48	M20x1.5	40	26	4°	0.67	0.39

## Rod Mount

Alignment compensator  
CF6

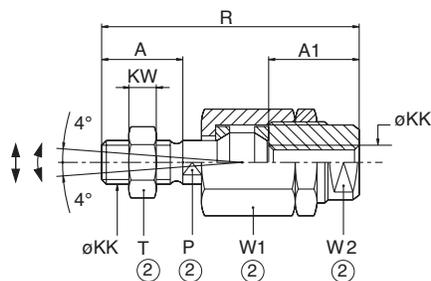

- ① Stroke
- ② Width across flats

Bore Ø (mm)	A	A1	P	ØKK	KW	R	T	W1	W2	X min.	Radial Compensation (mm)	Spherical Angular Compensation (°)	Weight (kg)
32	22	23	12	M20x1.25	6	71	17	30	19	56	0.7	4	0.22
40	24	23	12	M12x1.25	7	75	19	30	19	57	0.7	4	0.23
50	32	32	20	M16x1.5	8	103	24	41	27	79	1	4	0.66
63	32	32	20	M16x1.5	8	103	24	41	27	79	1	4	0.66
80	40	39	20	M20x1.5	10	119	30	41	27	89	1	4	0.7
100	40	39	20	M20x1.5	10	119	30	41	27	89	1	4	0.7

## Specifications



Construction	Foot Bracket (set of 2 items) C01, C03	Front or Rear Flange CF2, CR2
Bore Ø (mm)	stamped sheet steel	steel
32	P493A3124000A00	P493A3126000A00
40	P493A4124000A00	P493A4126000A00
50	P493A5124000A00	P493A5126000A00
63	P493A6124000A00	P493A6126000A00
80	P493A8124000A00	P493A8126000A00
100	P493A1124000A00	P493A1126000A00



Construction	Mid Trunnion MT4, MS4	Construction	Fixed Mid Trunnion FMT, FST
Bore Ø (mm)	cast iron	Bore Ø (mm)	cast iron
453		450	
32	P493B3111000A00	32	P493A3113000A00
40	P493A4111000A00	40	P493A4113000A00
50	P493A5111000A00	50	P493A5113000A00
63	P493A6111000A00	63	P493A6113000A00
80	P493A8111000A00	80	P493A8113000A00
100	P493A1111000A00	100	P493A1113000A00



Construction	Rod Clevis Mount CF4	Spherical Rod Eye Mount (Front Side) CF5	Alignment Compensator CF6
Bore Ø (mm)	steel	steel	steel
32	P493A3131000A00	P493A3132000A00	P493A3134000A00
40	P493A4131000A00	P493A4132000A00	P493A4134000A00
50-63	P493A5131000A00	P493A5132000A00	P493A5134000A00
80-100	P493A8131000A00	P493A8132000A00	P493A8134000A00

## Rear Mountings



Construction	Oscillating Bracket with Wide Fork Type Mount C08	Oscillating Bracket with Lugs C07
Bore Ø (mm)	light alloy	light alloy
32	P493A3121110A00	P493A3122100A00
40	P493A4121110A00	P493A4122100A00
50	P493A5121110A00	P493A5122100A00
63	P493A6121110A00	P493A6122100A00
80	P493A8121110A00	P493A8122100A00
100	P493A1121110A00	P493A1122100A00



Construction	Angular Clevis Bracket AB7	Oscillating Bracket with Narrow Fork Type Mount C14	Spherical Eye Mount (Back Side) C13	Angular Clevis Bracket Spherical Bearing AB5
Bore Ø (mm)	light alloy	steel	steel	steel
32	P493A3123110A00	P493A3129000A00	P493A3128000A00	P493A3127000A00
40	P493A4123110A00	P493A4129000A00	P493A4128000A00	P493A4127000A00
50	P493A5123110A00	P493A5129000A00	P493A5128000A00	P493A5127000A00
63	P493A6123110A00	P493A6129000A00	P493A6128000A00	P493A6127000A00
80	P493A8123110A00	P493A8129000A00	P493A8128000A00	P493A8127000A00
100	P493A1123110A00	P493A1129000A00	P493A1128000A00	P493A1127000A00

## Sensing Part Numbers

### P494A0022300A00

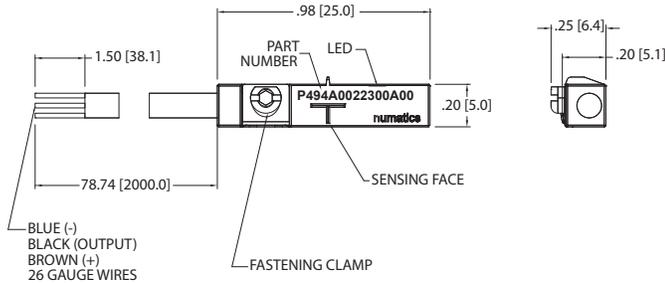

### P494A0022600A00

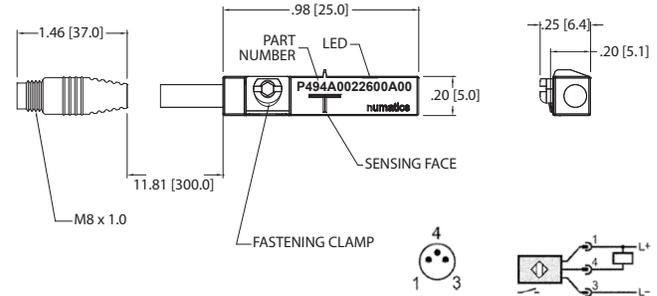

<b>ELECTRICAL DESIGN</b>	DC PNP
<b>OUTPUT</b>	Normally Open
<b>OPERATING VOLTAGE</b>	10-30 VDC
<b>CURRENT RATING</b>	100 mA
<b>SHORT-CIRCUIT PROTECTION</b>	Yes
<b>OVERLOAD PROTECTION</b>	Yes
<b>REVERSE POLARITY PROTECTION</b>	Yes
<b>VOLTAGE DROP</b>	< 2.5 V
<b>CURRENT CONSUMPTION</b>	< 12 mA
<b>REPEATABILITY</b>	< .2mm
<b>POWER-ON DELAY TIME</b>	< 30 ms
<b>SWITCH FREQUENCY</b>	> 3000 Hz
<b>AMBIENT TEMPERATURE</b>	-25°C to 85°C
<b>PROTECTION</b>	IP 67, III
<b>HYSTERESIS</b>	1.0mm
<b>MAGNETIC SENSITIVITY</b>	2.0 mT
<b>TRAVEL SPEED</b>	> 10 m/s
<b>HOUSING MATERIAL</b>	PA (Polyamide) Black; Fastening Clamp: Stainless Steel
<b>FUNCTION DISPLAY SWITCHING STATUS</b>	Yellow LED
<b>CONNECTION</b>	Flying Leads, Pur Cable (2m Long, 3 x26 Gauge Wire)
<b>REMARKS</b>	Clamping Screw with Combined Slot/Hexagon Socket Head AF 1.5 cULus - Class 2 Source Required
<b>ACCESSORIES</b>	Rubber Placeholder, Cable Clip, and Cut Sheet To Be Provided with Every Switch
<b>AGENCY APPROVALS</b>	CE cULus RoHS

<b>ELECTRICAL DESIGN</b>	DC PNP
<b>OUTPUT</b>	Normally Open
<b>OPERATING VOLTAGE</b>	10-30 VDC
<b>CURRENT RATING</b>	100 mA
<b>SHORT-CIRCUIT PROTECTION</b>	Yes
<b>OVERLOAD PROTECTION</b>	Yes
<b>REVERSE POLARITY PROTECTION</b>	Yes
<b>VOLTAGE DROP</b>	< 2.5 V
<b>CURRENT CONSUMPTION</b>	< 12 mA
<b>REPEATABILITY</b>	< .2mm
<b>POWER-ON DELAY TIME</b>	< 30 ms
<b>SWITCH FREQUENCY</b>	> 3000 Hz
<b>AMBIENT TEMPERATURE</b>	-25°C to 85°C
<b>PROTECTION</b>	IP 67, III
<b>HYSTERESIS</b>	1.0mm
<b>MAGNETIC SENSITIVITY</b>	2.0 mT
<b>TRAVEL SPEED</b>	> 10 m/s
<b>HOUSING MATERIAL</b>	PA (Polyamide) Black; Fastening Clamp: Stainless Steel
<b>FUNCTION DISPLAY SWITCHING STATUS</b>	Yellow LED
<b>CONNECTION</b>	M8 Connector, Pur Cable (.3 m)
<b>REMARKS</b>	Clamping Screw with Combined Slot/Hexagon Socket Head AF 1.5 cULus - Class 2 Source Required
<b>ACCESSORIES</b>	Rubber Placeholder, Cable Clip, and Cut Sheet To Be Provided with Every Switch
<b>AGENCY APPROVALS</b>	CE cULus RoHS

## Sensing Part Numbers

**P494A0022400A00**

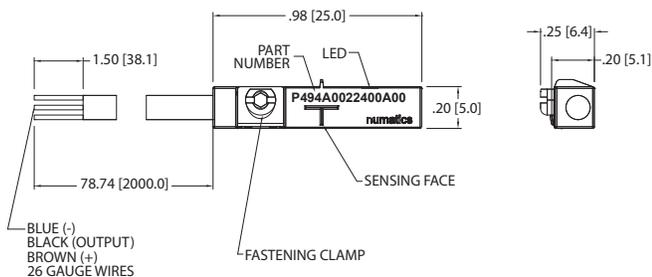

**P494A0022700A00**

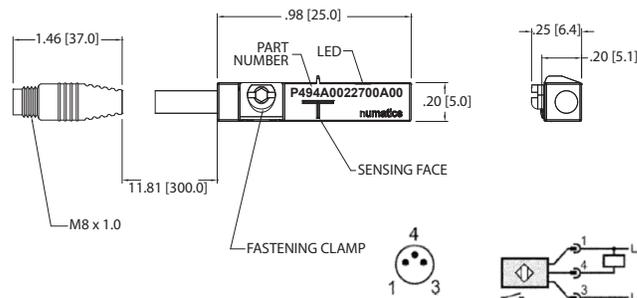

<b>ELECTRICAL DESIGN</b>	DC NPN
<b>OUTPUT</b>	Normally Open
<b>OPERATING VOLTAGE</b>	10-30 VDC
<b>CURRENT RATING</b>	100 mA
<b>SHORT-CIRCUIT PROTECTION</b>	Yes
<b>OVERLOAD PROTECTION</b>	Yes
<b>REVERSE POLARITY PROTECTION</b>	Yes
<b>VOLTAGE DROP</b>	< 2.5 V
<b>CURRENT CONSUMPTION</b>	< 12 mA
<b>REPEATABILITY</b>	< .2mm
<b>POWER-ON DELAY TIME</b>	< 30 ms
<b>SWITCH FREQUENCY</b>	> 3000 Hz
<b>AMBIENT TEMPERATURE</b>	-25°C to 85°C
<b>PROTECTION</b>	IP 67, III
<b>HYSTERESIS</b>	1.0mm
<b>MAGNETIC SENSITIVITY</b>	2.0 mT
<b>TRAVEL SPEED</b>	> 10 m/s
<b>HOUSING MATERIAL</b>	PA (Polyamide) Black; Fastening Clamp: Stainless Steel
<b>FUNCTION DISPLAY SWITCHING STATUS</b>	Yellow LED
<b>CONNECTION</b>	Flying Leads, Pur Cable (2m Long, 3 x26 Gauge Wire)
<b>REMARKS</b>	Clamping Screw with Combined Slot/Hexagon Socket Head AF 1.5 cULus - Class 2 Source Required
<b>ACCESSORIES</b>	Rubber Placeholder, Cable Clip, and Cut Sheet To Be Provided with Every Switch
<b>AGENCY APPROVALS</b>	CE cUL US RoHS

<b>ELECTRICAL DESIGN</b>	DC NPN
<b>OUTPUT</b>	Normally Open
<b>OPERATING VOLTAGE</b>	10-30 VDC
<b>CURRENT RATING</b>	100 mA
<b>SHORT-CIRCUIT PROTECTION</b>	Yes
<b>OVERLOAD PROTECTION</b>	Yes
<b>REVERSE POLARITY PROTECTION</b>	Yes
<b>VOLTAGE DROP</b>	< 2.5 V
<b>CURRENT CONSUMPTION</b>	< 12 mA
<b>REPEATABILITY</b>	< .2mm
<b>POWER-ON DELAY TIME</b>	< 30 ms
<b>SWITCH FREQUENCY</b>	> 3000 Hz
<b>AMBIENT TEMPERATURE</b>	-25°C to 85°C
<b>PROTECTION</b>	IP 67, III
<b>HYSTERESIS</b>	1.0mm
<b>MAGNETIC SENSITIVITY</b>	2.0 mT
<b>TRAVEL SPEED</b>	> 10 m/s
<b>HOUSING MATERIAL</b>	PA (Polyamide) Black; Fastening Clamp: Stainless Steel
<b>FUNCTION DISPLAY SWITCHING STATUS</b>	Yellow LED
<b>CONNECTION</b>	M8 Connector, Pur Cable (.3 m)
<b>REMARKS</b>	Clamping Screw with Combined Slot/Hexagon Socket Head AF 1.5 cULus - Class 2 Source Required
<b>ACCESSORIES</b>	Rubber Placeholder, Cable Clip, and Cut Sheet To Be Provided with Every Switch
<b>AGENCY APPROVALS</b>	CE cUL US RoHS

## Sensing Part Numbers

**P494A0021300A00**

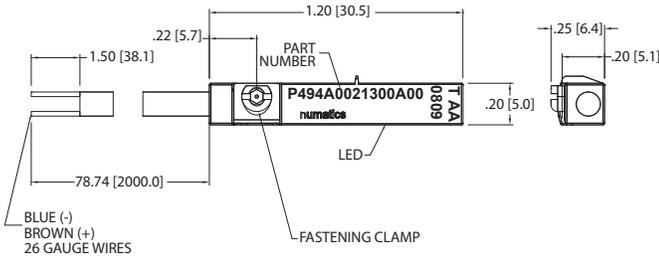

**P494A0021600A00**

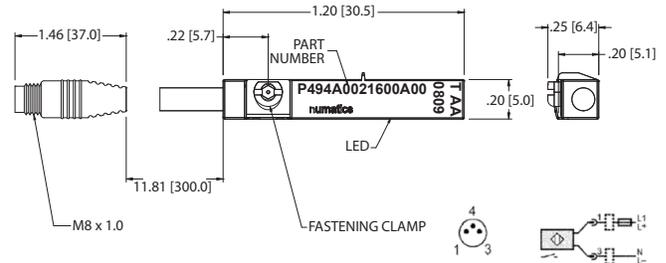

<b>ELECTRICAL DESIGN</b>	AC/DC REED
<b>OUTPUT</b>	Normally Open
<b>OPERATING VOLTAGE</b>	5-120 VAC/DC
<b>CURRENT RATING</b>	100 mA*
<b>SHORT-CIRCUIT PROTECTION</b>	No
<b>OVERLOAD PROTECTION</b>	No
<b>REVERSE POLARITY PROTECTION</b>	Yes
<b>VOLTAGE DROP</b>	< 5 V
<b>REPEATABILITY</b>	± .2mm
<b>MAKETIME INCLUDING BOUNCE</b>	< .6 ms
<b>BREAKTIME</b>	< .1 ms
<b>SWITCHING POWER (MAX)</b>	5 W
<b>SWITCH FREQUENCY</b>	1000 Hz
<b>AMBIENT TEMPERATURE</b>	-25°C to 70°C
<b>PROTECTION</b>	IP 67, II
<b>HYSTERESIS</b>	.9mm
<b>HOUSING MATERIAL</b>	PA (Polyamide) Black; Fastening Clamp: Stainless Steel
<b>FUNCTION DISPLAY SWITCHING STATUS</b>	Yellow LED
<b>CONNECTION</b>	Flying Leads, Pur Cable (2m Long, 2 x26 Gauge Wire)
<b>REMARKS</b>	*External Protective Circuit for Inductive Load (Valve, Contactor, Etc.) Necessary. Conforms to 2008 NEC Section 725 III, Class 2 Circuits  Clamping Screw with Combined Slot/Hexagon Socket Head AF 1.5. No LED Function in case of Polarity in DC Operation
<b>ACCESSORIES</b>	Rubber Placeholder, Cable Clip, and Cut Sheet To Be Provided with Every Switch
<b>AGENCY APPROVALS</b>	

<b>ELECTRICAL DESIGN</b>	AC/DC REED
<b>OUTPUT</b>	Normally Open
<b>OPERATING VOLTAGE</b>	5-60 VDC / 5-50 VAC #
<b>CURRENT RATING</b>	100 mA*
<b>SHORT-CIRCUIT PROTECTION</b>	No
<b>OVERLOAD PROTECTION</b>	No
<b>REVERSE POLARITY PROTECTION</b>	Yes
<b>VOLTAGE DROP</b>	< 5 V
<b>REPEATABILITY</b>	± .2mm
<b>MAKETIME INCLUDING BOUNCE</b>	< .6 ms
<b>BREAKTIME</b>	< .1 ms
<b>SWITCHING POWER (MAX)</b>	5 W
<b>SWITCH FREQUENCY</b>	1000 Hz
<b>AMBIENT TEMPERATURE</b>	-25°C to 70°C
<b>PROTECTION</b>	IP 67, II
<b>HYSTERESIS</b>	.9mm
<b>HOUSING MATERIAL</b>	PA (Polyamide) Black; Fastening Clamp: Stainless Steel
<b>FUNCTION DISPLAY SWITCHING STATUS</b>	Yellow LED
<b>CONNECTION</b>	M8 Connector, Pur Cable (.3m)
<b>REMARKS</b>	*External Protective Circuit for Inductive Load (Valve, Contactor, Etc.) Necessary. Conforms to 2008 NEC Section 725 III, Class 2 Circuits  # M8 Connector voltage limited to 5-60 VDC/ 5-50 VAC to conform with 2008 IEC 61076-2-104 Clamping Screw with Combined Slot/Hexagon Socket Head AF 1.5. No LED Function in case of Polarity in DC Operation
<b>ACCESSORIES</b>	Rubber Placeholder, Cable Clip, and Cut Sheet To Be Provided with Every Switch
<b>AGENCY APPROVALS</b>	











World Class Supplier of Pneumatic Components



## World Headquarters

### USA - Numatics, Incorporated

46280 Dylan Drive  
Novi, Michigan 48377

P: 248-596-3200  
F: 248-596-3201

### Canada - Numatics, Ltd

P: 519-758-2700  
F: 519-758-5540

### México - Ascomatica SA de CV

P: 52 55 58 09 56 40 (DF y Area metropolitana)  
P: 01 800 000 2726 (Interior de la República)  
F: 52 55 58 09 56 60

### Brazil - Ascoval Ind.e Comercio Ltda

P: (55) 11-4208-1700  
F: (55) 11-4195-3970